

Metallized Polypropylene Film Capacitor (Segmented design)

■ 外形圖 Outline Drawing

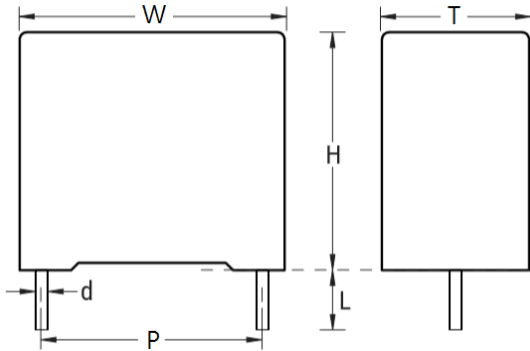

■ 構造 Construction

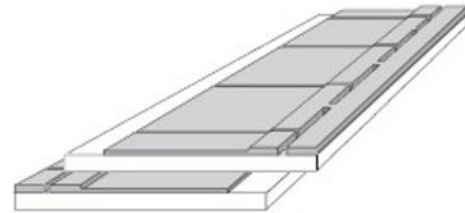

■ 典型應用 Typical Applications

作為開關電源的中間電路電容器·電子鎮流器·逆變器。(直流鏈路、直流濾波器和 PFC)

As intermediate circuit capacitors for SMPS, Electronic ballast, Inverter (DC-Link, DC-filter and PFC)

■ 特徵 Features

SMTP 系列僅推薦用於直流濾波器或直流阻斷電路·這意味施加在電容器上的電壓必須是單向紋波電壓。
The SMTP series is only recommended to use in DC-Filter or DC blocking circuits, It means the voltage applied to the capacitors must be unidirectional ripple voltage.

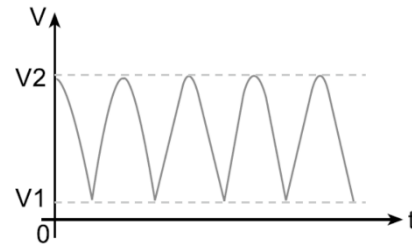

$$V1 \geq 0, V2 \leq UR, V_{rms} = (V2 - V1) \div \sqrt{2}, I_{rms} = 2\pi f \times C \times (V2 - V1) \div \sqrt{2}$$

■ 規格 Specifications

參考標準 Reference Standard	GB/T 10190 (IEC 60384-16)		
氣候類別 Climatic Category	40/105/21		
額定溫度 Rated Temperature	85°C		
工作溫度範圍 Operating Temperature Range	-40°C~+105°C (+85°C to +105°C: decreasing factor 1.25% per °C for UR)		
容值範圍 Capacitance Range	0.022μF ~ 22μF		
額定直流電壓 Rated (DC) Voltage	450Vdc	520Vdc	630Vdc
容值公差 Capacitance Tolerance	±5%(J) · ±10%(K) · ±20%(M)		
耐電壓 Voltage Proof	UR x 1.6, 5s (DC)		
損耗因素 Dissipation Factor	≤ 10 x 10 ⁻⁴ at 1kHz, (1Vrms Max. at 20°C)		
絕緣電阻 Insulation Resistance	UR < 500V, 100Vdc UR > 500V, 500Vdc	CR ≤ 0.33μF, IR ≥ 25000MΩ CR > 0.33μF, IR x CR ≥ 7500s	

Metallized Polypropylene Film Capacitor (Segmented design)

■ 產品代碼構成 Product code system (For Example)

SMTP	E	105	K	0450	D	B	15	15
型號 Type	內部使用 Internal use	容值 Capacitance	公差 Tolerance	額定電壓 Rated Voltage	交直流 AC/DC	引線成形 Lead forming	引線間距 Lead Pitch	引線長度 Lead Length
SMTP= Metallized Polypropylene Capacitor Segmented design	--	105 =1000nF =1.0μF	J=±5% K=±10% M=±20%	0450=450V 0520=520V 0630=630V	D=DC A=AC	(表一) Shown as Table I	10=10mm 15=15mm 23=22.5mm 28=27.5mm	04=3.5mm 15=15mm 23=23mm

(表一) Table I

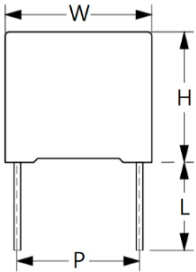
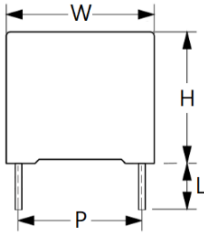
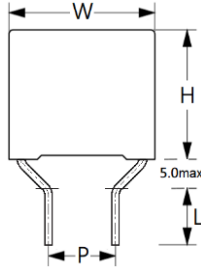
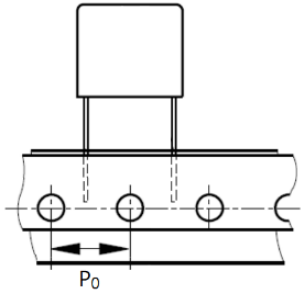
引線成形 Lead Forming			
B (Straight 15mm)	K (Short)	U (Vertical Kink)	T (Taping)
			

■ 標示 Marking (For Example)

Marking



1. WDC is a registered trademark of WINDAY	2. Capacitance: 1.0μF and Tolerance is K=±10%
3. Rated Voltage: 450Vdc	4. TP for Metallized polypropylene film capacitor

Metallized Polypropylene Film Capacitor

(Segmented design)

Miniature Version

■ Dimensions (mm)

450Vdc						
Cap. μF	W	H	T	P	d	Part number
0.12	13	9	4	10	0.6	SMTP_124+0450D*10**
0.15	13	9	4	10	0.6	SMTP_154+0450D*10**
0.18	13	11	5	10	0.6	SMTP_184+0450D*10**
0.22	13	11	5	10	0.6	SMTP_224+0450D*10**
0.27	13	12	6	10	0.6	SMTP_274+0450D*10**
0.33	13	12	6	10	0.6	SMTP_334+0450D*10**
0.39	13	13	7	10	0.6	SMTP_394+0450D*10**
0.47	13	13	7	10	0.6	SMTP_474+0450D*10**
0.56	13	14	8	10	0.6	SMTP_564+0450D*10**
0.68	13	14	8	10	0.6	SMTP_684+0450D*10**
0.22	18	11	5	15	0.8	SMTP_224+0450D*15**
0.33	18	11	5	15	0.8	SMTP_334+0450D*15**
0.39	18	11	5	15	0.8	SMTP_394+0450D*15**
0.47	18	11	5	15	0.8	SMTP_474+0450D*15**
0.56	18	12	6	15	0.8	SMTP_564+0450D*15**
0.68	18	12	7	15	0.8	SMTP_684+0450D*15**
0.82	18	12	7	15	0.8	SMTP_824+0450D*15**
1.0	18	13.5	7.5	15	0.8	SMTP_105+0450D*15**
1.2	18	14.5	8.5	15	0.8	SMTP_125+0450D*15**
1.5	18	16	10	15	0.8	SMTP_155+0450D*15**
1.8	18	16	10	15	0.8	SMTP_185+0450D*15**
2.2	18	19	10.8	15	0.8	SMTP_225+0450D*15**
1.0	26.5	15	6	22.5	0.8	SMTP_105+0450D*23**
1.2	26.5	15	6	22.5	0.8	SMTP_125+0450D*23**
1.5	26.5	16	7	22.5	0.8	SMTP_155+0450D*23**
1.8	26.5	16	7	22.5	0.8	SMTP_185+0450D*23**
2.2	26.5	17	8.5	22.5	0.8	SMTP_225+0450D*23**
2.7	26.5	17	8.5	22.5	0.8	SMTP_275+0450D*23**
3.3	26.5	19	10	22.5	0.8	SMTP_335+0450D*23**
3.9	26.5	19	10	22.5	0.8	SMTP_395+0450D*23**
4.7	26.5	20	11	22.5	0.8	SMTP_425+0450D*23**

450Vdc						
Cap. μF	W	H	T	P	d	Part number
5.6	26.5	22	12	22.5	0.8	SMTP_565+0450D*23**
6.8	26.5	24.5	15.5	22.5	0.8	SMTP_685+0450D*23**
8.2	26.5	24.5	15.5	22.5	0.8	SMTP_825+0450D*23**
3.3	32	18	9	27.5	0.8	SMTP_335+0450D*28**
3.9	32	18	9	27.5	0.8	SMTP_395+0450D*28**
4.7	32	20	11	27.5	0.8	SMTP_475+0450D*28**
5.6	32	20	11	27.5	0.8	SMTP_565+0450D*28**
6.8	32	22	13	27.5	0.8	SMTP_685+0450D*28**
8.2	32	24.5	15	27.5	0.8	SMTP_825+0450D*28**
10	32	24.5	15	27.5	0.8	SMTP_106+0450D*28**
12	32	28	17	27.5	0.8	SMTP_126+0450D*28**
15	32	33	18	27.5	0.8	SMTP_156+0450D*28**
18	32	37	22	27.5	0.8	SMTP_186+0450D*28**
22	32	37	22	27.5	0.8	SMTP_226+0450D*28**

(1) The symbol + means capacitance tolerance (J=±5%, K=±10%)

(2) The symbol * means style of lead forming

(3) The symbol ** means the lead length

Metallized Polypropylene Film Capacitor

(Segmented design)

Miniature Version

■ Dimensions (mm)

520Vdc						
Cap. μF	W	H	T	P	d	Part number
0.082	13	9	4	10	0.6	SMTP_823+0520D*10**
0.10	13	9	4	10	0.6	SMTP_104+0520D*10**
0.12	13	11	5	10	0.6	SMTP_124+0520D*10**
0.15	13	11	5	10	0.6	SMTP_154+0520D*10**
0.18	13	12	6	10	0.6	SMTP_184+0520D*10**
0.22	13	12	6	10	0.6	SMTP_224+0520D*10**
0.27	13	13	7	10	0.6	SMTP_274+0520D*10**
0.33	13	13	7	10	0.6	SMTP_334+0520D*10**
0.39	13	14	8	10	0.6	SMTP_394+0520D*10**
0.47	13	14	8	10	0.6	SMTP_474+0520D*10**
0.27	18	11	5	15	0.8	SMTP_274+0520D*15**
0.33	18	11	5	15	0.8	SMTP_334+0520D*15**
0.39	18	12	6	15	0.8	SMTP_394+0520D*15**
0.47	18	12	6	15	0.8	SMTP_474+0520D*15**
0.56	18	13	7	15	0.8	SMTP_564+0520D*15**
0.68	18	13.5	7.5	15	0.8	SMTP_684+0520D*15**
0.82	18	14.5	8.5	15	0.8	SMTP_824+0520D*15**
1.0	18	14.5	8.5	15	0.8	SMTP_105+0520D*15**
1.2	18	16	10	15	0.8	SMTP_125+0520D*15**
1.5	18	19	10.8	15	0.8	SMTP_155+0520D*15**
0.68	26.5	15	6	22.5	0.8	SMTP_684+0520D*23**
0.82	26.5	15	6	22.5	0.8	SMTP_824+0520D*23**
1.0	26.5	16	7	22.5	0.8	SMTP_105+0520D*23**
1.2	26.5	16	7	22.5	0.8	SMTP_125+0520D*23**
1.5	26.5	17	8.5	22.5	0.8	SMTP_155+0520D*23**
1.8	26.5	17	8.5	22.5	0.8	SMTP_185+0520D*23**
2.2	26.5	19	10	22.5	0.8	SMTP_225+0520D*23**
2.7	26.5	19	10	22.5	0.8	SMTP_275+0520D*23**
3.3	26.5	20	11	22.5	0.8	SMTP_335+0520D*23**
3.9	26.5	22	12	22.5	0.8	SMTP_395+0520D*23**
4.7	26.5	24.5	15.5	22.5	0.8	SMTP_475+0520D*23**

520Vdc						
Cap. μF	W	H	T	P	d	Part number
5.6	26.5	24.5	15.5	22.5	0.8	SMTP_565+0520D*23**
2.2	32	18	9	27.5	0.8	SMTP_225+0520D*28**
2.7	32	18	9	27.5	0.8	SMTP_275+0520D*28**
3.3	32	20	11	27.5	0.8	SMTP_335+0520D*28**
3.9	32	20	11	27.5	0.8	SMTP_395+0520D*28**
4.7	32	22	13	27.5	0.8	SMTP_475+0520D*28**
5.6	32	22	13	27.5	0.8	SMTP_565+0520D*28**
6.8	32	24.5	15	27.5	0.8	SMTP_685+0520D*28**
8.2	32	24.5	15	27.5	0.8	SMTP_825+0520D*28**
10	32	28	17	27.5	0.8	SMTP_106+0520D*28**
12	32	33	18	27.5	0.8	SMTP_126+0520D*28**
15	32	37	22	27.5	0.8	SMTP_156+0520D*28**
18	32	37	22	27.5	0.8	SMTP_186+0520D*28**

(1) The symbol + means capacitance tolerance (J=±5%, K=±10%)

(2) The symbol * means style of lead forming

(3) The symbol ** means the lead length

Metallized Polypropylene Film Capacitor

(Segmented design)

Miniature Version

■ Dimensions (mm)

630Vdc						
Cap. μF	W	H	T	P	d	Part number
0.056	13	9	4	10	0.6	SMTP_563+0630D*10**
0.068	13	9	4	10	0.6	SMTP_683+0630D*10**
0.082	13	11	5	10	0.6	SMTP_823+0630D*10**
0.10	13	11	5	10	0.6	SMTP_104+0630D*10**
0.12	13	12	6	10	0.6	SMTP_124+0630D*10**
0.15	13	12	6	10	0.6	SMTP_154+0630D*10**
0.18	13	13	7	10	0.6	SMTP_184+0630D*10**
0.22	13	13	7	10	0.6	SMTP_224+0630D*10**
0.27	13	14	8	10	0.6	SMTP_274+0630D*10**
0.33	13	14	8	10	0.6	SMTP_334+0630D*10**
0.18	18	11	5	15	0.8	SMTP_184+0630D*15**
0.22	18	11	5	15	0.8	SMTP_224+0630D*15**
0.27	18	12	6	15	0.8	SMTP_274+0630D*15**
0.33	18	12	6	15	0.8	SMTP_334+0630D*15**
0.39	18	12	7	15	0.8	SMTP_394+0630D*15**
0.47	18	13.5	7.5	15	0.8	SMTP_474+0630D*15**
0.56	18	14.5	8.5	15	0.8	SMTP_564+0630D*15**
0.68	18	14.5	8.5	15	0.8	SMTP_684+0630D*15**
0.82	18	16	10	15	0.8	SMTP_824+0630D*15**
1.0	18	16	10	15	0.8	SMTP_105+0630D*15**
1.2	18	19	10.8	15	0.8	SMTP_125+0630D*15**
0.47	26.5	15	6	22.5	0.8	SMTP_474+0630D*23**
0.56	26.5	15	6	22.5	0.8	SMTP_564+0630D*23**
0.68	26.5	16	7	22.5	0.8	SMTP_684+0630D*23**
0.82	26.5	16	7	22.5	0.8	SMTP_824+0630D*23**
1.0	26.5	17	8.5	22.5	0.8	SMTP_105+0630D*23**
1.2	26.5	17	8.5	22.5	0.8	SMTP_125+0630D*23**
1.5	26.5	19	10	22.5	0.8	SMTP_155+0630D*23**
1.8	26.5	19	10	22.5	0.8	SMTP_185+0630D*23**
2.2	26.5	20	11	22.5	0.8	SMTP_225+0630D*23**
2.7	26.5	22	12	22.5	0.8	SMTP_275+0630D*23**

630Vdc						
Cap. μF	W	H	T	P	d	Part number
3.3	26.5	24.5	15.5	22.5	0.8	SMTP_335+0630D*23**
3.9	26.5	24.5	15.5	22.5	0.8	SMTP_395+0630D*23**
1.8	32	18	9	27.5	0.8	SMTP_185+0630D*28**
2.2	32	20	11	27.5	0.8	SMTP_225+0630D*28**
2.7	32	20	11	27.5	0.8	SMTP_275+0630D*28**
3.3	32	22	13	27.5	0.8	SMTP_335+0630D*28**
3.9	32	22	13	27.5	0.8	SMTP_395+0630D*28**
4.7	32	24.5	15	27.5	0.8	SMTP_475+0630D*28**
5.6	32	28	17	27.5	0.8	SMTP_565+0630D*28**
6.8	32	29	19	27.5	0.8	SMTP_685+0630D*28**
8.2	32	29	19	27.5	0.8	SMTP_825+0630D*28**
10	32	37	22	27.5	0.8	SMTP_106+0630D*28**
12	32	37	22	27.5	0.8	SMTP_126+0630D*28**

(1) The symbol + means capacitance tolerance (J=±5%, K=±10%)

(2) The symbol * means style of lead forming

(3) The symbol ** means the lead length

■ Dimensions (mm)

450Vdc						
Cap. μF	W	H	T	P	d	Part number
0.068	13	9	4	10	0.6	SMTP_683+0450D*10**
0.082	13	9	4	10	0.6	SMTP_823+0450D*10**
0.10	13	11	5	10	0.6	SMTP_104+0450D*10**
0.12	13	11	5	10	0.6	SMTP_124+0450D*10**
0.15	13	12	6	10	0.6	SMTP_154+0450D*10**
0.18	13	12	6	10	0.6	SMTP_184+0450D*10**
0.22	13	13	7	10	0.6	SMTP_224+0450D*10**
0.27	13	13	7	10	0.6	SMTP_274+0450D*10**
0.33	13	14	8	10	0.6	SMTP_334+0450D*10**
0.10	18	9.5	5	15	0.8	SMTP_104+0450D*15**
0.12	18	11	5	15	0.8	SMTP_124+0450D*15**
0.15	18	11	5	15	0.8	SMTP_154+0450D*15**
0.18	18	11	5	15	0.8	SMTP_184+0450D*15**
0.22	18	11	5	15	0.8	SMTP_224+0450D*15**
0.27	18	12	6	15	0.8	SMTP_274+0450D*15**
0.33	18	12	6	15	0.8	SMTP_334+0450D*15**
0.39	18	13.5	7.5	15	0.8	SMTP_394+0450D*15**
0.47	18	13.5	7.5	15	0.8	SMTP_474+0450D*15**
0.56	18	13.5	7.5	15	0.8	SMTP_564+0450D*15**
0.68	18	16	10	15	0.8	SMTP_684+0450D*15**
0.82	18	16	10	15	0.8	SMTP_824+0450D*15**
1.0	18	19	10.8	15	0.8	SMTP_105+0450D*15**
0.27	26.5	15	6	22.5	0.8	SMTP_274+0450D*23**
0.33	26.5	15	6	22.5	0.8	SMTP_334+0450D*23**
0.39	26.5	15	6	22.5	0.8	SMTP_394+0450D*23**
0.47	26.5	15	6	22.5	0.8	SMTP_474+0450D*23**
0.56	26.5	16	7	22.5	0.8	SMTP_564+0450D*23**
0.68	26.5	16	7	22.5	0.8	SMTP_684+0450D*23**
0.82	26.5	16	7	22.5	0.8	SMTP_824+0450D*23**
1.0	26.5	17	8.5	22.5	0.8	SMTP_105+0450D*23**

450Vdc						
Cap. μF	W	H	T	P	d	Part number
1.2	26.5	19	10	22.5	0.8	SMTP_125+0450D*23**
1.5	26.5	19	10	22.5	0.8	SMTP_155+0450D*23**
1.8	26.5	22	12	22.5	0.8	SMTP_185+0450D*23**
0.68	32	18	9	27.5	0.8	SMTP_684+0450D*28**
0.82	32	18	9	27.5	0.8	SMTP_824+0450D*28**
1.0	32	18	9	27.5	0.8	SMTP_105+0450D*28**
1.2	32	18	9	27.5	0.8	SMTP_125+0450D*28**
1.5	32	18	9	27.5	0.8	SMTP_155+0450D*28**
1.8	32	20	11	27.5	0.8	SMTP_185+0450D*28**
2.2	32	20	11	27.5	0.8	SMTP_225+0450D*28**
2.7	32	22	13	27.5	0.8	SMTP_275+0450D*28**
3.3	32	22	13	27.5	0.8	SMTP_335+0450D*28**
3.9	32	24.5	15	27.5	0.8	SMTP_395+0450D*28**
4.7	32	33	18	27.5	0.8	SMTP_475+0450D*28**
5.6	32	33	18	27.5	0.8	SMTP_565+0450D*28**
6.8	32	33	18	27.5	0.8	SMTP_685+0450D*28**
8.2	32	33	18	27.5	0.8	SMTP_825+0450D*28**

(1) The symbol + means capacitance tolerance (J=±5%, K=±10%)

(2) The symbol * means style of lead forming

(3) The symbol ** means the lead length

■ Dimensions (mm)

520Vdc						
Cap. μF	W	H	T	P	d	Part number
0.047	13	9	4	10	0.6	SMTP_473+0520D*10**
0.056	13	9	4	10	0.6	SMTP_563+0520D*10**
0.068	13	9	4	10	0.6	SMTP_683+0520D*10**
0.082	13	11	5	10	0.6	SMTP_823+0520D*10**
0.10	13	11	5	10	0.6	SMTP_104+0520D*10**
0.12	13	12	6	10	0.6	SMTP_124+0520D*10**
0.15	13	12	6	10	0.6	SMTP_154+0520D*10**
0.18	13	13	7	10	0.6	SMTP_184+0520D*10**
0.22	13	13	7	10	0.6	SMTP_224+0520D*10**
0.27	13	14	8	10	0.6	SMTP_274+0520D*10**
0.033	18	11	5	15	0.8	SMTP_333+0520D*15**
0.039	18	11	5	15	0.8	SMTP_333+0520D*15**
0.047	18	11	5	15	0.8	SMTP_473+0520D*15**
0.056	18	11	5	15	0.8	SMTP_563+0520D*15**
0.068	18	11	5	15	0.8	SMTP_683+0520D*15**
0.082	18	11	5	15	0.8	SMTP_823+0520D*15**
0.10	18	11	5	15	0.8	SMTP_104+0520D*15**
0.12	18	11	5	15	0.8	SMTP_124+0520D*15**
0.15	18	11	5	15	0.8	SMTP_154+0520D*15**
0.18	18	11	5	15	0.8	SMTP_184+0520D*15**
0.22	18	12	6	15	0.8	SMTP_224+0520D*15**
0.27	18	12	6	15	0.8	SMTP_274+0520D*15**
0.33	18	13.5	7.5	15	0.8	MTP3384+0520D*15**
0.39	18	13.5	7.5	15	0.8	SMTP_394+0520D*15**
0.47	18	14.5	8.5	15	0.8	SMTP_474+0520D*15**
0.56	18	16	10	15	0.8	SMTP_564+0520D*15**
0.68	18	16	10	15	0.8	SMTP_684+0520D*15**
0.82	18	19	10.8	15	0.8	SMTP_824+0520D*15**
1.0	18	19	10.8	15	0.8	SMTP_105+0520D*15**
0.18	26.5	15	6	22.5	0.6	SMTP_184+0520D*23**

520Vdc						
Cap. μF	W	H	T	P	d	Part number
0.22	26.5	15	6	22.5	0.6	SMTP_224+0520D*23**
0.27	26.5	15	6	22.5	0.6	SMTP_274+0520D*23**
0.33	26.5	15	6	22.5	0.6	SMTP_334+0520D*23**
0.39	26.5	15	6	22.5	0.6	SMTP_394+0520D*23**
0.47	26.5	15	6	22.5	0.6	SMTP_474+0520D*23**
0.56	26.5	16	7	22.5	0.6	SMTP_564+0520D*23**
0.68	26.5	16	7	22.5	0.6	SMTP_684+0520D*23**
0.82	26.5	17	8.5	22.5	0.8	SMTP_824+0520D*23**
1.0	26.5	19	10	22.5	0.8	SMTP_105+0520D*23**
1.2	26.5	19	10	22.5	0.8	SMTP_125+0520D*23**
1.5	26.5	22	12	22.5	0.8	SMTP_155+0520D*23**
1.8	26.5	22	12	22.5	0.8	SMTP_185+0520D*23**
0.27	32	18	9	27.5	0.8	SMTP_274+0520D*28**
0.33	32	18	9	27.5	0.8	SMTP_334+0520D*28**
0.39	32	18	9	27.5	0.8	SMTP_394+0520D*28**
0.47	32	18	9	27.5	0.8	SMTP_474+0520D*28**
0.56	32	18	9	27.5	0.8	SMTP_564+0520D*28**
0.68	32	18	9	27.5	0.8	SMTP_684+0520D*28**
0.82	32	18	9	27.5	0.8	SMTP_824+0520D*28**
1.0	32	18	9	27.5	0.8	SMTP_105+0520D*28**
1.2	32	18	9	27.5	0.8	SMTP_125+0520D*28**
1.5	32	20	11	27.5	0.8	SMTP_155+0520D*28**
1.8	32	20	11	27.5	0.8	SMTP_185+0520D*28**
2.2	32	22	13	27.5	0.8	SMTP_225+0520D*28**
2.7	32	24.5	15	27.5	0.8	SMTP_275+0520D*28**
3.3	32	28	14	27.5	0.8	SMTP_335+0520D*28**
3.9	32	28	14	27.5	0.8	SMTP_395+0520D*28**
4.7	32	33	18	27.5	0.8	SMTP_475+0520D*28**
5.6	32	33	18	27.5	0.8	SMTP_565+0520D*28**
6.8	32	33	18	27.5	0.8	SMTP_685+0520D*28**



■ Dimensions (mm)

630Vdc						
Cap. μF	W	H	T	P	d	Part number
0.022	13	9	4	10	0.6	SMTP_223+0630D*10**
0.027	13	9	4	10	0.6	SMTP_273+0630D*10**
0.033	13	9	4	10	0.6	SMTP_333+0630D*10**
0.039	13	9	4	10	0.6	SMTP_393+0630D*10**
0.047	13	11	5	10	0.6	SMTP_473+0630D*10**
0.056	13	11	5	10	0.6	SMTP_563+0630D*10**
0.068	13	11	5	10	0.6	SMTP_683+0630D*10**
0.082	13	12	6	10	0.6	SMTP_823+0630D*10**
0.10	13	12	6	10	0.6	SMTP_104+0630D*10**
0.12	13	13	7	10	0.6	SMTP_124+0630D*10**
0.15	13	13	7	10	0.6	SMTP_154+0630D*10**
0.18	13	14	8	10	0.6	SMTP_184+0630D*10**
0.068	18	11	5	15	0.8	SMTP_683+0630D*15**
0.082	18	11	5	15	0.8	SMTP_823+0630D*15**
0.10	18	11	5	15	0.8	SMTP_104+0630D*15**
0.12	18	11	5	15	0.8	SMTP_124+0630D*15**
0.15	18	12	6	15	0.8	SMTP_154+0630D*15**
0.18	18	12	6	15	0.8	SMTP_184+0630D*15**
0.22	18	13.5	7.5	15	0.8	SMTP_224+0630D*15**
0.27	18	13.5	7.5	15	0.8	SMTP_274+0630D*15**
0.33	18	14.5	8.5	15	0.8	SMTP_334+0630D*15**
0.39	18	16	10	15	0.8	SMTP_394+0630D*15**
0.47	18	16	10	15	0.8	SMTP_474+0630D*15**
0.56	18	19	10.8	15	0.8	SMTP_564+0630D*15**
0.68	18	19	10.8	15	0.8	SMTP_684+0630D*15**
0.15	26.5	15	6	22.5	0.6	SMTP_154+0630D*23**
0.18	26.5	15	6	22.5	0.6	SMTP_184+0630D*23**
0.22	26.5	15	6	22.5	0.6	SMTP_224+0630D*23**
0.27	26.5	15	6	22.5	0.6	SMTP_274+0630D*23**
0.33	26.5	15	6	22.5	0.6	SMTP_334+0630D*23**

630Vdc						
Cap. μF	W	H	T	P	d	Part number
0.39	26.5	16	7	22.5	0.6	SMTP_394+0630D*23**
0.47	26.5	16	7	22.5	0.6	SMTP_474+0630D*23**
0.56	26.5	17	8.5	22.5	0.8	SMTP_564+0630D*23**
0.68	26.5	17	8.5	22.5	0.8	SMTP_684+0630D*23**
0.82	26.5	19	10	22.5	0.8	SMTP_824+0630D*23**
1.0	26.5	19	10	22.5	0.8	SMTP_105+0630D*23**
1.2	26.5	22	12	22.5	0.8	SMTP_125+0630D*23**
0.27	32	18	9	27.5	0.8	SMTP_274+0630D*28**
0.33	32	18	9	27.5	0.8	SMTP_334+0630D*28**
0.39	32	18	9	27.5	0.8	SMTP_394+0630D*28**
0.47	32	18	9	27.5	0.8	SMTP_474+0630D*28**
0.56	32	18	9	27.5	0.8	SMTP_564+0630D*28**
0.68	32	18	9	27.5	0.8	SMTP_684+0630D*28**
0.82	32	18	9	27.5	0.8	SMTP_824+0630D*28**
1.0	32	20	11	27.5	0.8	SMTP_105+0630D*28**
1.2	32	20	11	27.5	0.8	SMTP_125+0630D*28**
1.5	32	22	13	27.5	0.8	SMTP_155+0630D*28**
1.8	32	22	13	27.5	0.8	SMTP_185+0630D*28**
2.2	32	24.5	15	27.5	0.8	SMTP_225+0630D*28**
2.7	32	28	14	27.5	0.8	SMTP_275+0630D*28**
3.3	32	33	18	27.5	0.8	SMTP_335+0630D*28**
3.9	32	33	18	27.5	0.8	SMTP_395+0630D*28**

(1) The symbol + means capacitance tolerance (J=±5%, K=±10%)

(2) The symbol * means style of lead forming

(3) The symbol ** means the lead length

Metallized Polypropylene Film Capacitor (Segmented design)

■ 檢驗要求 Inspection requirements

試驗項目 Test items	性能要求 Performance requirements	試驗條件 Conditions of test	
電容量 Capacitance	在規定偏差範圍內 Within the tolerance specified	1kHz, 1Vrms Max. at 20°C	
損耗因素 Dissipation Factor	$\leq 10 \times 10^{-4}$ at 1kHz	1Vrms Max. at 20°C	
耐電壓 Voltage proof	無擊穿或飛弧 Shall be no abnormality	引線間 Between terminals $U_R \times 1.6$ (Vdc) Test of 5sec.	
絕緣電阻 Insulation resistance	$C_R \leq 0.33\mu F$, $IR \geq 25000M\Omega$ $C_R > 0.33\mu F$, $IR \times C_R \geq 7500s$	$U_R < 500V$ at 100Vdc, $U_R > 500V$ at 500Vdc, For 60sec / 20°C	
引出端強度 Robustness of terminations	無斷線, 電容器無可見損壞 No wire breakage and no damage of capacitor	拉力 Tensile U_{a1} (Duration : 10s±1s)	
		線徑 Wire diameter	負載 Load
		$d \leq 0.8mm$	10N (±10%)
		$d \leq 1.25mm$	20N (±10%)
		彎曲 Bending U_b (4*90°, duration : 2 times/bend)	
		Wire diameter	Load
		$d \leq 0.8mm$ 5N (±10%)	
		$d \leq 1.25mm$ 10N (±10%)	
耐焊接熱 Resistance to soldering heat	(1) 無可見損壞 No visible damage (2) $\Delta C/C \leq 3\%$ of the initial value (3) $\tan \delta \leq 0.004$ of increased value	焊接溫度 Solder temperature: 260±5°C 焊接時間 Solder time: 5±0.5sec	
可焊性 Solderability		焊接溫度 Solder temperature: 235±5°C 焊接時間 Solder time: 2±0.5sec	
溫度快速變化 Rapid change of temperature	應目視檢查電容器, 並無可見損壞 The capacitors shall be visually examined and there shall be no visible damage.	下限溫度 Lower category temperature: -40°C 上限溫度 Upper category temperature: 85°C 循環次數 Number of cycles: 5 times 持續時間 Duration $t_1 = 30$ min	
振動 Vibration	最後測量 Final inspection (1) $\Delta C/C \leq 3\%$ of the initial value (2) Increase of $\tan \delta$ over the value ≤ 0.004 (3) $IR \geq 50\%$ of the applicable limits	頻率範圍 Frequency range: 10~55Hz 振幅軸向 Course: X · Y · Z (axis) 持續時間 2h / axis (6h in total) 位移振幅 Displacement amplitude: 0.75mm	
碰撞 Bump		加速度 Acceleration: 400m/s ² , 4000 times 脈沖持續時間 Pulse duration: 6ms	

■ 檢驗要求 Inspection requirements

試驗項目 Test items	性能要求 Performance requirements	試驗條件 Conditions of test
氣候序列 Climatic sequence	(1) No visible damage, Legible marking (2) $\Delta C/C \leq 5\%$ of the initial value (3) Increase of $\tan \delta$ over the value ≤ 0.005 (4) $IR \geq 50\%$ of the applicable limits (5) Voltage proof : No permanent breakdown	乾熱 Dry Heat 上限溫度 Upper Temperature: 85°C, 16Hrs 循環濕熱 Damp heat, cyclic, Test Db, first cycle
		寒冷 Cold 下限溫度 Lower Temperature: -40°C, 2Hrs 循環濕熱 Damp heat, cyclic, Test Db, remaining cycle
濕熱穩態 Damp Heat Steady State	(1) No visible damage, Legible marking (2) Voltage proof : $U_R \times 1.0$ (3) $\Delta C/C \leq 5\%$ of the Initial value (4) Increase of $\tan \delta$ over the value ≤ 0.002 (5) $IR \geq 50\%$ of the applicable limits	溫度 +40°C, 濕度 93%, 21 天 +40°C and 93% RH, 21 days
耐久性 Endurance	(1) No Visible Damage (2) $\Delta C/C \leq 5\%$ of the initial value (3) Increase of $\tan \delta$ over the value ≤ 0.004 (4) $IR \geq 50\%$ of the applicable limits	實驗電壓 $U_R \times 125\%$, 實驗溫度 Temperature: +85°C 實驗時間 Time: 1000Hrs
充電和放電 Charge and discharge	(1) $\Delta C/C \leq 5\%$ of the initial value (2) Increase of $\tan \delta$ over the value ≤ 0.005 (3) $IR \geq 50\%$ of the applicable limits	實驗電壓 Test voltage : Rated (DC) voltage 充放電 Charge and discharge: 0.5sec/time 重複次數 Repeated for 10000 cycles

Metallized Polypropylene Film Capacitor (Segmented design)

■ 薄膜電容器焊接指南 Soldering Guidelines for Film Capacitors

聚丙烯膜電容器對熱特別敏感 (聚丙烯膜的熔點為 160°C ~ 170°C) , 波峰焊可能具有破壞性 , 尤其是對於小型聚丙烯膜電容器 (引線間距為 5 mm 至 15 mm) , 焊接過程中必須非常小心。

一般來說 , IEC 出版物 61760-1 第 2 版中的波峰焊接曲線可作為成功焊接的可靠指南。(請參見圖 1)

Polypropylene capacitors are especially sensitive to heat (the melting point of polypropylene is 160 – 170°C).

Wave soldering can be destructive, especially for mechanically small polypropylene capacitors (with lead spacing of 5 – 15 mm), and great care must be taken during soldering. In general, the wave soldering curve from IEC Publication 61760-1 Edition 2 serves as a solid guideline for successful soldering. See Figure 1.

通孔的薄膜電容器不建議採用回流焊。將電容器暴露在超過上述建議限值可能會導致電容器退化或永久性損壞。

Reflow soldering is not recommended for through-hole film capacitors. Exposing capacitors to a soldering profile in excess of the recommended limits may result in degradation or permanent damage to the capacitors.

請勿將聚丙烯膜電容器通過粘合劑固化爐來固化表面安裝部件的樹脂 , 須在表面安裝零件固化後插入通孔零件。

如果通孔部件必須通過粘合劑固化過程 , 請諮詢 WINDAY , 討論烘箱中的實際溫度分布。

建議最多進行兩次焊接循環。在第二次焊接循環之前 , 請留出時間使電容器表面溫度恢復到正常溫度。

Do not place the polypropylene capacitor through an adhesive curing oven to cure resin for surface mount components.

Insert through-hole parts after curing the surface mount parts. Contact WINDAY to discuss the actual temperature profile in the oven, if through-hole components must pass through the adhesive curing process.

A maximum two soldering cycles is recommended.

Allow time for the capacitor surface temperature to return to normal before the second soldering cycle.

■ 波峰焊建議 Wave Soldering Recommendations (Figure 1)

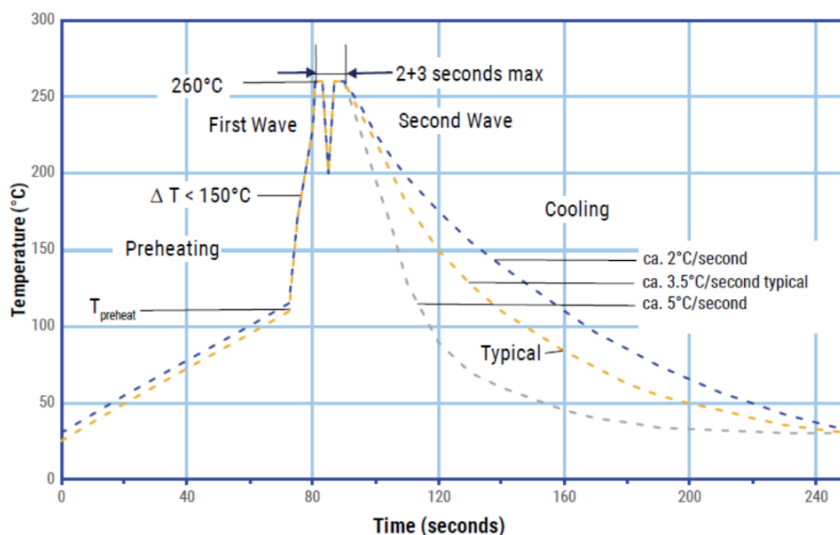

Metallized Polypropylene Film Capacitor (Segmented design)

■ 波峰焊建議 Wave Soldering Recommendations (Continue)

1. 該表顯示了焊接過程的最高設置溫度 The tables indicates the maximum set-up temperature of the soldering process

介電薄膜材料 Dielectric Film Material	最高預熱溫度 Max. Preheat Temperature		最高峰值焊接溫度 Max. Peak Soldering Temperature	
	Pitch ≤ 15 mm	Pitch > 15 mm	Pitch ≤ 15 mm	Pitch > 15 mm
	聚乙酯膜 Polyester	130°C	130°C	270°C
聚丙烯膜 Polypropylene	110°C	130°C	260°C	270°C

2. 電容器內部測得的最高溫度 The maximum temperature measured inside the capacitor

介電薄膜材料 Dielectric Film Material	元件內部測得的最高溫度 Maximum Temperature Measured Inside the Element
聚乙酯膜 Polyester	160°C
聚丙烯膜 Polypropylene	110°C

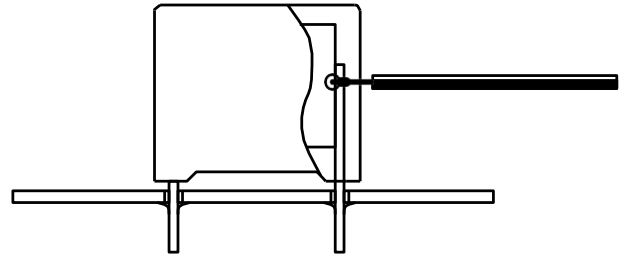

設置溫度，使元件內的最高溫度低於極限：

Set the temperature so that inside the element the maximum temperature is below the limit.

■ 儲存條件和期限 Storage conditions and duration

包裝好的電容器應存放在清潔、通風、乾燥的庫房內，不靠近熱源，不受陽光直射，嚴禁與化學試劑、酸和有害氣體一起儲存。T_{stg} = +5°C 至 +35°C，最大相對濕度為 75%，無冷凝，儲存一年。

Packaged capacitors should be kept in clean, ventilated, dry coffers, not near the heat source, not subject to direct sunlight, is strictly prohibited and chemical reagents, acid and harmful gas storage together.

T_{stg} = +5°C to +35°C with relative humidity of maximum 75% without condensation, storage for one year.

Metallized Polypropylene Film Capacitor (Segmented design)

■ 典型圖 Typical graphs

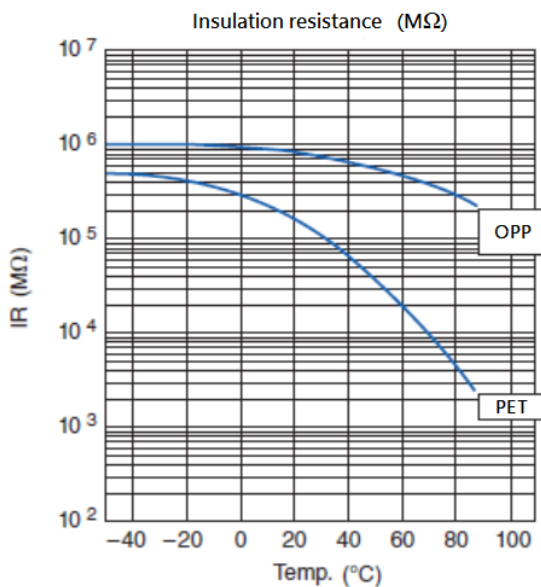
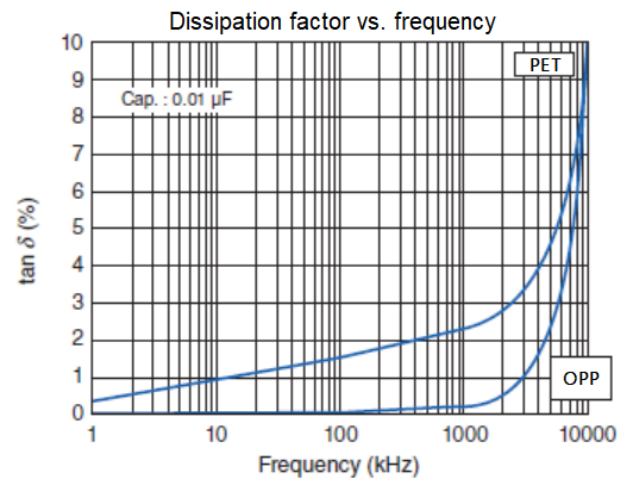
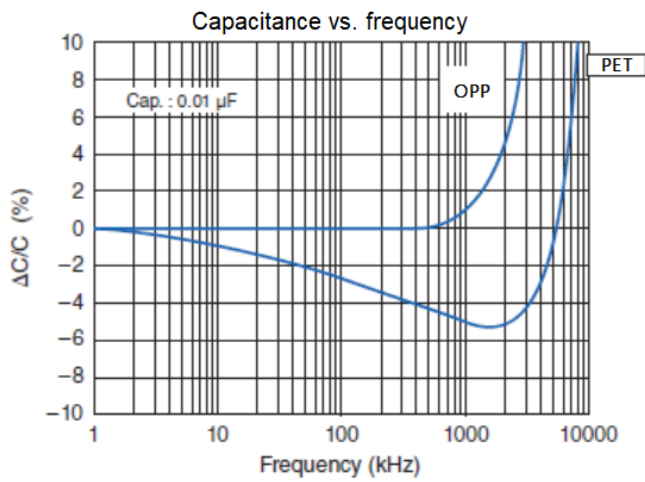
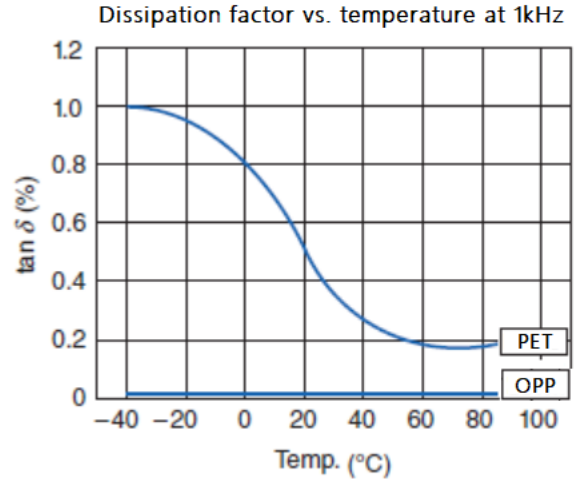
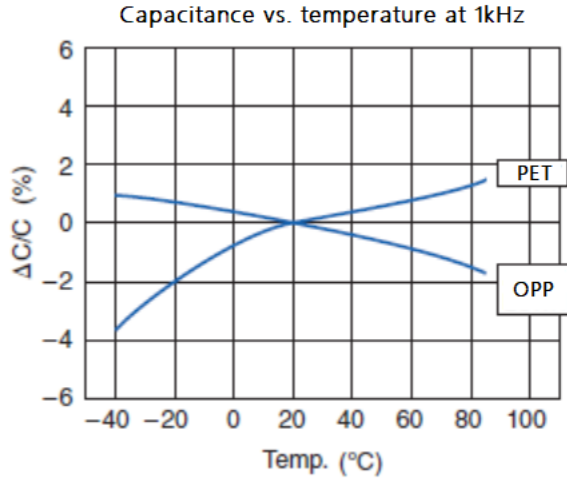

PET :	聚乙酯膜 Polyester film capacitor
OPP :	聚丙烯膜 Polypropylene film capacitor

Metallized Polypropylene Film Capacitor (Segmented design)

■ 引線編帶 Lead Taping (IEC 60286-2) Table II

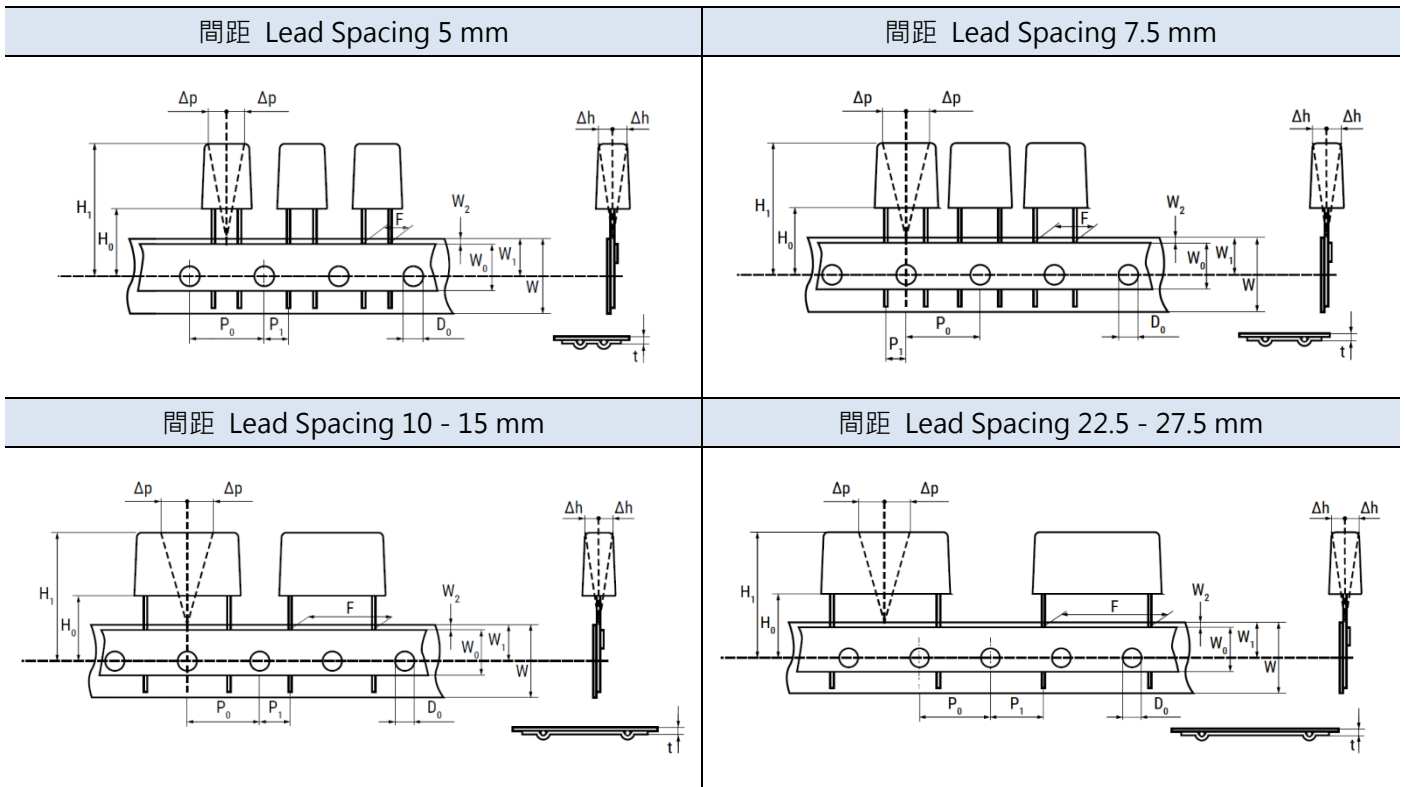

■ 編帶規格 Taping Specification

尺寸單位 Dimensions in mm								
引線間距 Lead Spacing	+0.8/-0.2	F	5	7.5	10	15	22.5	27.5
載帶寬度 Carrier Tape Width	+1/-0.5	W	18	18	18	18	18	18
膠帶寬度 Hold-down Tape Width	Minimum	W ₀	9.5	9.5	9.5	9.5	9.5	9.5
鏈孔位置 Position of Sprocket Hole	±0.5	W ₁	9	9	9	9	9	9
帶與帶距 Distance Between Tapes	Minimum	W ₂	3	3	3	3	3	3
鏈孔直徑 Sprocket Hole Diameter	±0.2	D ₀	4	4	4	4	4	4
進料孔距 Feed Hole Lead Spacing	±0.2 ⁽¹⁾	P ₀ ⁽³⁾	12.7	12.7	12.7	12.7	12.7	12.7
引線-鏈孔 Distance Lead-Feed Hole	±0.7	P ₁	3.85	3.75	7.7	5.2	7.8	5.3
平面偏差 Deviation Tape - Plane	Minimum	Δp	1.3	1.3	1.3	1.3	1.3	1.3
橫向偏差 Lateral Deviation	±2	Δh	2	2	2	2	2	2
總厚度 Total Thickness	±0.2	T	0.7	0.7	0.7	0.7	0.7	0.7
鏈孔-本體 Sprocket Hole/Cap Body	±0.5	H ₀ ⁽²⁾	18.5	18.5	18.5	18.5	18.5	18.5

(1) 最大累計進料孔誤差：每20個零件 1mm / Maximum cumulative feed hole error, 1 mm per 20 parts.

(2) 16.5 mm 可根據要求提供 / 16.5 mm available on request.

(3) 15.0 mm 可根據要求提供 / 15.0 mm available on request (F ≥ 10mm).