

EMI Suppression Capacitor, Class X1

■ 外形圖 Outline Drawing ( For Example)

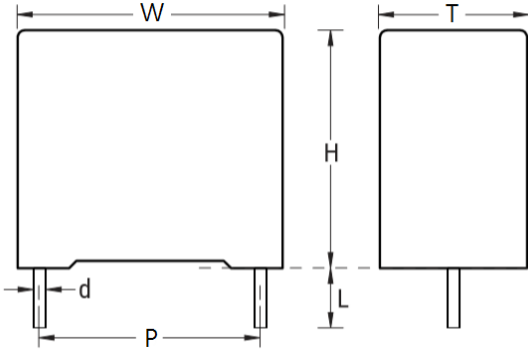

■ 典型應用

適用於需要 X1 安全等級的跨線應用中的電磁干擾 (EMI) 抑制。用於電容器故障不會導致觸電的情況。不用於“串聯電源”型應用。

■ 特徵

金屬化聚丙烯薄膜徑向鍍錫引線。  
電容器封裝在自熄耐溶劑塑料殼中。  
採用符合 UL 94 V-0 要求的熱固性樹脂材料。

■ 規格 Specifications

|                                    |   |                                       |        |        |
|------------------------------------|---|---------------------------------------|--------|--------|
| 參考標準 Reference Standard            | GB/T 6346.14 (IEC 60384-14)   |                                       |        |        |
| 容量範圍 Capacitance Range             | 0.001 $\mu$ F ~ 4.7 $\mu$ F   |                                       |        |        |
| 容量誤差 Capacitance Tolerance         | $\pm 10\%$ (K)  |                                       |        |        |
| 額定電壓 Rated Voltage ( $U_R$ )       | 310Vac  | 380Vac                                | 440Vac | 500Vac |
| 氣候類別 Climatic Category             | 40/110/56   |                                       |        |        |
| 工作溫度範圍 Operating Temperature Range | -40°C ~ 110°C   |                                       |        |        |
| 被動可燃性等級 Passive Flammability Class | B   |                                       |        |        |
| 耐電壓 Voltage Proof                  | 引線間 Between Terminals   | $U_R \times 4.3$ (DC), 60s            |        |        |
|                                    | 引線與外殼間 Between Terminal and Case                                      | $U_R \times 200\% + 1500$ Vac, 60sec. |        |        |
| 損耗因素 Dissipation Factor            | $\leq 10 \times 10^{-4}$ at 1kHz, (1Vrms Max. at 20°C)                |                                       |        |        |
| 絕緣電阻 Insulation Resistance         | $C_R \leq 0.33\mu$ F, IR $\geq 15000$ M $\Omega$                      |                                       |        |        |
|                                    | $C_R > 0.33\mu$ F, IR $\times C_R \geq 5000$ s (100Vdc, 60sec / 20°C) |                                       |        |        |

■ 構造 Construction

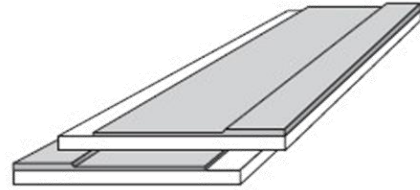

■ Typical Applications

For worldwide use in electromagnetic interference (EMI) suppression in across-the-line applications requiring X1 safety classification. Intended for use in situations where capacitor failure would not result in exposure to electric shock. Not for use in "series with mains" type applications.

■ Features

Metallized polypropylene film with radial leads of tinned wire. The capacitor is encapsulated in a self-extinguishing solvent resistant plastic case with thermosetting resin material meeting UL 94 V-0 requirements.

EMI Suppression Capacitor, Class X1

■ 產品代碼構成 Product code system (For Example)

| SWX1        | J                    | 104               | K               | D4XX              | D             | B                    | 15                 | 15                  |
|-------------|----------------------|-------------------|-----------------|-------------------|---------------|----------------------|--------------------|---------------------|
| 型號<br>Type  | 內部使用<br>Internal Use | 容值<br>Capacitance | 公差<br>Tolerance | 外殼代碼<br>Case Code | 電壓<br>Voltage | 引線成形<br>Lead Forming | 引線間距<br>Lead Pitch | 引線長度<br>Lead Length |
| SWX1=       | --                   | 104               | K=±10%          | D2X5=18*12*6      | B=310V        | (表一)                 | 08=7.5mm           | 04=3.5mm            |
| EMI         |                      | =100nF            |                 | D3XX=18*13.5*7.5  | C=380V        | Shown as             | 10=10mm            | 15=15mm             |
| Suppression |                      | =0.1μF            |                 | D4XX=18*14.5*8.5  | D=440V        | Table I              | 15=15mm            | 23=23mm             |
| Capacitor   |                      |                   |                 | E4XX=26.5*19*10   | E=500V        |                      | 23=22.5mm          |                     |
| Class-X1    |                      |                   |                 | F3XX=31*25*14     |               |                      | 28=27.5mm          |                     |

(表一) Table I

| 引線成形 Lead Forming |           |                   |            |
|-------------------|-----------|-------------------|------------|
| B (Straight 15mm) | K (Short) | U (Vertical Kink) | T (Taping) |
|                   |           |                   |            |

■ 標示 Marking (For Example)

Marking

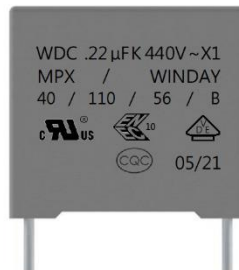

|                                     |   |
|-------------------------------------|---|
| 1. WDC is a trademark of WINDAY     | 2. Capacitance: .22μF indicates 0.22μF or 220nF   |
| 3. Capacitors Tolerance: K=±10%     | 4. Rated Voltage: 440V~                           |
| 5. Capacitors Class: X1             | 6. Type of the Capacitors: MPX                    |
| 7. Manufacturer: WINDAY             | 8. Climatic Category: 40/110/56                   |
| 9. Passive flammability category: B | 10. Recognized Approval Mark (Date Code: 05M/21Y) |

## EMI Suppression Capacitor, Class X1

## ■ Dimensions (mm)

| 310Vac / 380Vac |    |      |      |    |     |                     |
|-----------------|----|------|------|----|-----|---------------------|
| Cap.<br>μF      | W  | H    | T    | P  | d   | Part number         |
| 0.010           | 13 | 9    | 4    | 10 | 0.6 | SWX1_103KC1XX+*10** |
| 0.012           | 13 | 9    | 4    | 10 | 0.6 | SWX1_123KC1XX+*10** |
| 0.015           | 13 | 9    | 4    | 10 | 0.6 | SWX1_153KC1XX+*10** |
| 0.018           | 13 | 11   | 5    | 10 | 0.6 | SWX1_183KC2X1+*10** |
| 0.022           | 13 | 11   | 5    | 10 | 0.6 | SWX1_223KC2X1+*10** |
| 0.027           | 13 | 11   | 5    | 10 | 0.6 | SWX1_273KC2X1+*10** |
| 0.033           | 13 | 11   | 5    | 10 | 0.6 | SWX1_333KC2X1+*10** |
| 0.039           | 13 | 12   | 6    | 10 | 0.6 | SWX1_393KC3XX+*10** |
| 0.047           | 13 | 12   | 6    | 10 | 0.6 | SWX1_473KC3XX+*10** |
| 0.056           | 13 | 13   | 7    | 10 | 0.6 | SWX1_563KC4LT+*10** |
| 0.068           | 13 | 14   | 8    | 10 | 0.6 | SWX1_683KC5LT+*10** |
| 0.010           | 18 | 11   | 5    | 15 | 0.8 | SWX1_103KD1XX+*15** |
| 0.012           | 18 | 11   | 5    | 15 | 0.8 | SWX1_123KD1XX+*15** |
| 0.015           | 18 | 11   | 5    | 15 | 0.8 | SWX1_153KD1XX+*15** |
| 0.018           | 18 | 11   | 5    | 15 | 0.8 | SWX1_183KD1XX+*15** |
| 0.022           | 18 | 11   | 5    | 15 | 0.8 | SWX1_223KD1XX+*15** |
| 0.027           | 18 | 11   | 5    | 15 | 0.8 | SWX1_273KD1XX+*15** |
| 0.033           | 18 | 11   | 5    | 15 | 0.8 | SWX1_333KD1XX+*15** |
| 0.039           | 18 | 11   | 5    | 15 | 0.8 | SWX1_393KD1XX+*15** |
| 0.047           | 18 | 11   | 5    | 15 | 0.8 | SWX1_473KD1XX+*15** |
| 0.056           | 18 | 11   | 5    | 15 | 0.8 | SWX1_563KD1XX+*15** |
| 0.068           | 18 | 12   | 6    | 15 | 0.8 | SWX1_683KD2XX+*15** |
| 0.082           | 18 | 12   | 6    | 15 | 0.8 | SWX1_823KD2XX+*15** |
| 0.10            | 18 | 12   | 6    | 15 | 0.8 | SWX1_104KD2XX+*15** |
| 0.12            | 18 | 13.5 | 7.5  | 15 | 0.8 | SWX1_124KD3XX+*15** |
| 0.15            | 18 | 14.5 | 8.5  | 15 | 0.8 | SWX1_154KD4XX+*15** |
| 0.18            | 18 | 14.5 | 8.5  | 15 | 0.8 | SWX1_184KD4XX+*15** |
| 0.22            | 18 | 15.5 | 9.5  | 15 | 0.8 | SWX1_224KD5XX+*15** |
| 0.27            | 18 | 19   | 10.8 | 15 | 0.8 | SWX1_274KD7XX+*15** |
| 0.33            | 18 | 19   | 10.8 | 15 | 0.8 | SWX1_334KD7XX+*15** |

| 310Vac / 380Vac |      |      |     |      |     |                     |
|-----------------|------|------|-----|------|-----|---------------------|
| Cap.<br>μF      | W    | H    | T   | P    | d   | Part number         |
| 0.039           | 26.5 | 15   | 6   | 22.5 | 0.8 | SWX1_393KE1XX+*23** |
| 0.047           | 26.5 | 15   | 6   | 22.5 | 0.8 | SWX1_473KE1XX+*23** |
| 0.056           | 26.5 | 15   | 6   | 22.5 | 0.8 | SWX1_563KE1XX+*23** |
| 0.068           | 26.5 | 15   | 6   | 22.5 | 0.8 | SWX1_683KE1XX+*23** |
| 0.082           | 26.5 | 15   | 6   | 22.5 | 0.8 | SWX1_823KE1XX+*23** |
| 0.10            | 26.5 | 15   | 6   | 22.5 | 0.8 | SWX1_104KE1XX+*23** |
| 0.12            | 26.5 | 15   | 6   | 22.5 | 0.8 | SWX1_124KE1XX+*23** |
| 0.15            | 26.5 | 15   | 6   | 22.5 | 0.8 | SWX1_154KE1XX+*23** |
| 0.18            | 26.5 | 15   | 6   | 22.5 | 0.8 | SWX1_184KE1XX+*23** |
| 0.22            | 26.5 | 16.5 | 7   | 22.5 | 0.8 | SWX1_224KE2XX+*23** |
| 0.27            | 26.5 | 16.5 | 7   | 22.5 | 0.8 | SWX1_274KE2XX+*23** |
| 0.33            | 26.5 | 17   | 8.5 | 22.5 | 0.8 | SWX1_334KE3XX+*23** |
| 0.39            | 26.5 | 19   | 10  | 22.5 | 0.8 | SWX1_394KE4XX+*23** |
| 0.47            | 26.5 | 19   | 10  | 22.5 | 0.8 | SWX1_474KE4XX+*23** |
| 0.56            | 26   | 20   | 11  | 22.5 | 0.8 | SWX1_564KE5XX+*23** |
| 0.68            | 26   | 21.5 | 12  | 22.5 | 0.8 | SWX1_684KE6XX+*23** |
| 0.82            | 26.5 | 23   | 13  | 22.5 | 0.8 | SWX1_824KE7XX+*23** |

(1) The symbol + means the voltage (B=310V, C=380V, D=440V, E=500V)

(2) The symbol \* means style of lead forming

(3) The symbol \*\* means the lead length

## EMI Suppression Capacitor, Class X1

## ■ Dimensions (mm)

| 310Vac / 380Vac |      |      |      |      |     |                     |
|-----------------|------|------|------|------|-----|---------------------|
| Cap.<br>μF      | W    | H    | T    | P    | d   | Part number         |
| 0.15            | 31   | 18   | 9    | 27.5 | 0.8 | SWX1_154KF5XX+*28** |
| 0.18            | 31   | 18   | 9    | 27.5 | 0.8 | SWX1_184KF5XX+*28** |
| 0.22            | 31   | 18   | 9    | 27.5 | 0.8 | SWX1_224KF5XX+*28** |
| 0.27            | 31   | 18   | 9    | 27.5 | 0.8 | SWX1_274KF5XX+*28** |
| 0.33            | 31   | 18   | 9    | 27.5 | 0.8 | SWX1_334KF5XX+*28** |
| 0.39            | 31   | 18   | 9    | 27.5 | 0.8 | SWX1_394KF5XX+*28** |
| 0.47            | 31   | 18   | 9    | 27.5 | 0.8 | SWX1_474KF5XX+*28** |
| 0.56            | 31.4 | 19.5 | 10.8 | 27.5 | 0.8 | SWX1_564KF1XX+*28** |
| 0.68            | 31.4 | 19.5 | 10.8 | 27.5 | 0.8 | SWX1_684KF1XX+*28** |
| 0.82            | 31.4 | 19.5 | 10.8 | 27.5 | 0.8 | SWX1_824KF1XX+*28** |
| 1.0             | 31   | 25   | 14   | 27.5 | 0.8 | SWX1_105KF3XX+*28** |
| 1.2             | 32   | 25.5 | 16   | 27.5 | 0.8 | SWX1_125KF4XX+*28** |
| 1.5             | 32   | 25.5 | 16   | 27.5 | 0.8 | SWX1_155KF4XX+*28** |
| 1.8             | 32   | 28   | 18   | 27.5 | 0.8 | SWX1_185KF13X+*28** |
| 2.2             | 32   | 28   | 18   | 27.5 | 0.8 | SWX1_225KF13X+*28** |
| 0.33            | 42.5 | 24   | 13   | 37.5 | 1.0 | SWX1_334KJ8XM+*38** |
| 0.39            | 42.5 | 24   | 13   | 37.5 | 1.0 | SWX1_394KJ8XM+*38** |
| 0.47            | 42.5 | 24   | 13   | 37.5 | 1.0 | SWX1_474KJ8XM+*38** |
| 0.56            | 42.5 | 24   | 13   | 37.5 | 1.0 | SWX1_564KJ8XM+*38** |
| 0.68            | 42.5 | 24   | 13   | 37.5 | 1.0 | SWX1_684KJ8XM+*38** |
| 0.82            | 42.5 | 24   | 13   | 37.5 | 1.0 | SWX1_824KJ8XM+*38** |
| 1.0             | 42.5 | 24   | 13   | 37.5 | 1.0 | SWX1_105KJ8XM+*38** |
| 1.2             | 42.5 | 24   | 13   | 37.5 | 1.0 | SWX1_125KJ8XM+*38** |
| 1.5             | 42.5 | 24   | 13   | 37.5 | 1.0 | SWX1_155KJ8XM+*38** |
| 1.8             | 42.5 | 24   | 13   | 37.5 | 1.0 | SWX1_185KJ8XM+*38** |
| 2.2             | 41.5 | 34   | 20.5 | 37.5 | 1.0 | SWX1_225KJ15L+*38** |
| 2.7             | 41.5 | 34   | 20.5 | 37.5 | 1.0 | SWX1_275KJ15L+*38** |
| 3.3             | 41.5 | 34   | 20.5 | 37.5 | 1.0 | SWX1_335KJ15L+*38** |
| 3.9             | 41.5 | 35.5 | 22.5 | 37.5 | 1.0 | SWX1_395KJ20L+*38** |
| 4.7             | 41.5 | 35.5 | 22.5 | 37.5 | 1.0 | SWX1_475KJ20L+*38** |

| 440Vac / 500Vac |    |    |   |     |     |                     |
|-----------------|----|----|---|-----|-----|---------------------|
| Cap.<br>μF      | W  | H  | T | P   | d   | Part number         |
| 0.0010          | 10 | 9  | 4 | 7.5 | 0.6 | SWX1_102KB3LT+*08** |
| 0.0012          | 10 | 9  | 4 | 7.5 | 0.6 | SWX1_122KB3LT+*08** |
| 0.0015          | 10 | 9  | 4 | 7.5 | 0.6 | SWX1_152KB3LT+*08** |
| 0.0018          | 10 | 9  | 4 | 7.5 | 0.6 | SWX1_182KB3LT+*08** |
| 0.0022          | 10 | 9  | 4 | 7.5 | 0.6 | SWX1_222KB3LT+*08** |
| 0.0027          | 10 | 9  | 4 | 7.5 | 0.6 | SWX1_272KB3LT+*08** |
| 0.0033          | 10 | 9  | 4 | 7.5 | 0.6 | SWX1_332KB3LT+*08** |
| 0.0039          | 10 | 9  | 4 | 7.5 | 0.6 | SWX1_392KB3LT+*08** |
| 0.0047          | 10 | 9  | 4 | 7.5 | 0.6 | SWX1_472KB3LT+*08** |
| 0.0056          | 10 | 9  | 4 | 7.5 | 0.6 | SWX1_562KB3LT+*08** |
| 0.0068          | 10 | 11 | 5 | 7.5 | 0.6 | SWX1_682KB4LT+*08** |
| 0.0082          | 10 | 11 | 5 | 7.5 | 0.6 | SWX1_822KB4LT+*08** |
| 0.010           | 10 | 11 | 5 | 7.5 | 0.6 | SWX1_103KB4LT+*08** |
| 0.012           | 10 | 12 | 6 | 7.5 | 0.6 | SWX1_123KB5LT+*08** |
| 0.0010          | 13 | 9  | 4 | 10  | 0.6 | SWX1_102KC1XX+*10** |
| 0.0012          | 13 | 9  | 4 | 10  | 0.6 | SWX1_122KC1XX+*10** |
| 0.0015          | 13 | 9  | 4 | 10  | 0.6 | SWX1_152KC1XX+*10** |
| 0.0018          | 13 | 9  | 4 | 10  | 0.6 | SWX1_182KC1XX+*10** |
| 0.0022          | 13 | 9  | 4 | 10  | 0.6 | SWX1_222KC1XX+*10** |
| 0.0027          | 13 | 9  | 4 | 10  | 0.6 | SWX1_272KC1XX+*10** |
| 0.0033          | 13 | 9  | 4 | 10  | 0.6 | SWX1_332KC1XX+*10** |
| 0.0039          | 13 | 9  | 4 | 10  | 0.6 | SWX1_392KC1XX+*10** |
| 0.0047          | 13 | 9  | 4 | 10  | 0.6 | SWX1_472KC1XX+*10** |
| 0.0056          | 13 | 9  | 4 | 10  | 0.6 | SWX1_562KC1XX+*10** |
| 0.0068          | 13 | 9  | 4 | 10  | 0.6 | SWX1_682KC1XX+*10** |
| 0.0082          | 13 | 9  | 4 | 10  | 0.6 | SWX1_822KC1XX+*10** |
| 0.010           | 13 | 9  | 4 | 10  | 0.6 | SWX1_103KC1XX+*10** |

(1) The symbol + means the voltage (B=310V, C=380V, D=440V, E=500V)

(2) The symbol \* means style of lead forming

(3) The symbol \*\* means the lead length

## EMI Suppression Capacitor, Class X1

## ■ Dimensions (mm)

| 440Vac / 500Vac |      |      |      |      |     |                     |
|-----------------|------|------|------|------|-----|---------------------|
| Cap.<br>μF      | W    | H    | T    | P    | d   | Part number         |
| 0.012           | 13   | 11   | 5    | 10   | 0.6 | SWX1_123KC2X1+*10** |
| 0.015           | 13   | 11   | 5    | 10   | 0.6 | SWX1_153KC2X1+*10** |
| 0.018           | 13   | 11   | 5    | 10   | 0.6 | SWX1_183KC2X1+*10** |
| 0.022           | 13   | 11   | 5    | 10   | 0.6 | SWX1_223KC2X1+*10** |
| 0.027           | 13   | 12   | 6    | 10   | 0.6 | SWX1_273KC3XX+*10** |
| 0.033           | 13   | 12   | 6    | 10   | 0.6 | SWX1_333KC3XX+*10** |
| 0.039           | 13   | 13   | 7    | 10   | 0.6 | SWX1_393KC4LT+*10** |
| 0.047           | 13   | 14   | 8    | 10   | 0.6 | SWX1_473KC5LT+*10** |
| 0.056           | 13   | 14   | 8    | 10   | 0.6 | SWX1_563KC5LT+*10** |
| 0.010           | 18   | 11   | 5    | 15   | 0.8 | SWX1_103KD1XX+*15** |
| 0.012           | 18   | 11   | 5    | 15   | 0.8 | SWX1_123KD1XX+*15** |
| 0.015           | 18   | 11   | 5    | 15   | 0.8 | SWX1_153KD1XX+*15** |
| 0.018           | 18   | 11   | 5    | 15   | 0.8 | SWX1_183KD1XX+*15** |
| 0.022           | 18   | 11   | 5    | 15   | 0.8 | SWX1_223KD1XX+*15** |
| 0.027           | 18   | 11   | 5    | 15   | 0.8 | SWX1_273KD1XX+*15** |
| 0.033           | 18   | 11   | 5    | 15   | 0.8 | SWX1_333KD1XX+*15** |
| 0.039           | 18   | 12   | 6    | 15   | 0.8 | SWX1_393KD2XX+*15** |
| 0.047           | 18   | 12   | 6    | 15   | 0.8 | SWX1_473KD2XX+*15** |
| 0.056           | 18   | 13.5 | 7.5  | 15   | 0.8 | SWX1_563KD3XX+*15** |
| 0.068           | 18   | 13.5 | 7.5  | 15   | 0.8 | SWX1_683KD3XX+*15** |
| 0.082           | 18   | 14.5 | 8.5  | 15   | 0.8 | SWX1_823KD4XX+*15** |
| 0.10            | 18   | 14.5 | 8.5  | 15   | 0.8 | SWX1_104KD4XX+*15** |
| 0.12            | 18   | 15.5 | 9.5  | 15   | 0.8 | SWX1_124KD5XX+*15** |
| 0.15            | 18   | 19   | 10.8 | 15   | 0.8 | SWX1_154KD7XX+*15** |
| 0.18            | 18   | 19   | 10.8 | 15   | 0.8 | SWX1_184KD7XX+*15** |
| 0.039           | 26.5 | 15   | 6    | 22.5 | 0.8 | SWX1_393KE1XX+*23** |
| 0.047           | 26.5 | 15   | 6    | 22.5 | 0.8 | SWX1_473KE1XX+*23** |
| 0.056           | 26.5 | 15   | 6    | 22.5 | 0.8 | SWX1_563KE1XX+*23** |
| 0.068           | 26.5 | 15   | 6    | 22.5 | 0.8 | SWX1_683KE1XX+*23** |
| 0.082           | 26.5 | 15   | 6    | 22.5 | 0.8 | SWX1_823KE1XX+*23** |
| 0.10            | 26.5 | 15   | 6    | 22.5 | 0.8 | SWX1_104KE1XX+*23** |

| 440Vac / 500Vac |      |      |      |      |     |                     |
|-----------------|------|------|------|------|-----|---------------------|
| Cap.<br>μF      | W    | H    | T    | P    | d   | Part number         |
| 0.12            | 26.5 | 15   | 6    | 22.5 | 0.8 | SWX1_124KE1XX+*23** |
| 0.15            | 26.5 | 16.5 | 7    | 22.5 | 0.8 | SWX1_154KE2XX+*23** |
| 0.18            | 26.5 | 17   | 8.5  | 22.5 | 0.8 | SWX1_184KE3XX+*23** |
| 0.22            | 26.5 | 17   | 8.5  | 22.5 | 0.8 | SWX1_224KE3XX+*23** |
| 0.27            | 26.5 | 19   | 10   | 22.5 | 0.8 | SWX1_274KE4XX+*23** |
| 0.33            | 26   | 20   | 11   | 22.5 | 0.8 | SWX1_334KE5XX+*23** |
| 0.39            | 26   | 20   | 11   | 22.5 | 0.8 | SWX1_394KE5XX+*23** |
| 0.47            | 26.5 | 23   | 13   | 22.5 | 0.8 | SWX1_474KE7XX+*23** |
| 0.56            | 26   | 25   | 15   | 22.5 | 0.8 | SWX1_564KE24L+*23** |
| 0.15            | 31   | 18   | 9    | 27.5 | 0.8 | SWX1_154KF5XX+*28** |
| 0.18            | 31   | 18   | 9    | 27.5 | 0.8 | SWX1_184KF5XX+*28** |
| 0.22            | 31   | 18   | 9    | 27.5 | 0.8 | SWX1_224KF5XX+*28** |
| 0.27            | 31   | 18   | 9    | 27.5 | 0.8 | SWX1_274KF5XX+*28** |
| 0.33            | 31   | 18   | 9    | 27.5 | 0.8 | SWX1_334KF5XX+*28** |
| 0.39            | 31.4 | 19.5 | 10.8 | 27.5 | 0.8 | SWX1_394KF1XX+*28** |
| 0.47            | 31.4 | 19.5 | 10.8 | 27.5 | 0.8 | SWX1_474KF1XX+*28** |
| 0.56            | 31.5 | 21.6 | 13   | 27.5 | 0.8 | SWX1_564KF2XX+*28** |
| 0.68            | 31   | 25   | 14   | 27.5 | 0.8 | SWX1_684KF3XX+*28** |
| 1.0             | 32   | 25.5 | 16   | 27.5 | 0.8 | SWX1_105KF4XX+*28** |
| 1.2             | 32   | 28   | 18   | 27.5 | 0.8 | SWX1_125KF13X+*28** |
| 1.5             | 31   | 31   | 22   | 27.5 | 0.8 | SWX1_155KF8XX+*28** |

(1) The symbol + means the voltage (B=310V, C=380V, D=440V, E=500V)

(2) The symbol \* means style of lead forming

(3) The symbol \*\* means the lead length

## EMI Suppression Capacitor, Class X1

## ■ Dimensions (mm)

| 440Vac / 500Vac |      |      |      |      |     |                     |
|-----------------|------|------|------|------|-----|---------------------|
| Cap.<br>μF      | W    | H    | T    | P    | d   | Part number         |
| 0.33            | 42.5 | 24   | 13   | 37.5 | 1.0 | SWX1_334KJ8XM+*38** |
| 0.39            | 42.5 | 24   | 13   | 37.5 | 1.0 | SWX1_394KJ8XM+*38** |
| 0.47            | 42.5 | 24   | 13   | 37.5 | 1.0 | SWX1_474KJ8XM+*38** |
| 0.56            | 42.5 | 24   | 13   | 37.5 | 1.0 | SWX1_564KJ8XM+*38** |
| 0.68            | 42.5 | 24   | 13   | 37.5 | 1.0 | SWX1_684KJ8XM+*38** |
| 0.82            | 42.5 | 24   | 13   | 37.5 | 1.0 | SWX1_824KJ8XM+*38** |
| 1.0             | 42.5 | 24   | 13   | 37.5 | 1.0 | SWX1_105KJ8XM+*38** |
| 1.2             | 42.5 | 24   | 13   | 37.5 | 1.0 | SWX1_125KJ8XM+*38** |
| 1.5             | 41.5 | 30   | 17   | 37.5 | 1.0 | SWX1_155KXXXX+*38** |
| 1.8             | 41.5 | 30   | 17   | 37.5 | 1.0 | SWX1_185KXXXX+*38** |
| 2.2             | 41.5 | 34   | 20.5 | 37.5 | 1.0 | SWX1_225KJ15L+*38** |
| 2.7             | 41.5 | 35.5 | 22.5 | 37.5 | 1.0 | SWX1_275KJ20L+*38** |
| 3.3             | 41.5 | 41   | 27.5 | 37.5 | 1.0 | SWX1_335KJ16L+*38** |
| 3.9             | 41.5 | 41   | 27.5 | 37.5 | 1.0 | SWX1_395KJ16L+*38** |
| 4.7             | 41.5 | 41   | 27.5 | 37.5 | 1.0 | SWX1_475KJ16L+*38** |

(1) The symbol + means the voltage (B=310V, C=380V, D=440V, E=500V)

(2) The symbol \* means style of lead forming

(3) The symbol \*\* means the lead length

■ 檢驗要求 Inspection requirements

| 試驗項目 Test items                                 | 性能要求 Performance requirements   | 試驗條件 Conditions of test   |                    |
|---|---|---|--------------------|
| 4.3 引出端強度<br>Robustness of terminations         | 無斷線，電容器無可見損壞<br>No wire breakage and no damage of capacitor<br>最終測量結果 Final measurements<br>(1) 無可見損壞 No visible damage<br>(2) $\Delta C/C \leq 5\%$ of the initial value   | 拉力 Tensile $U_{a1}$ (Duration : 10s $\pm$ 1s)   |                    |
|   |   | 線徑 Wire diameter  | 負載 Load            |
|   |   | $d \leq 0.8\text{mm}$   | 10N ( $\pm 10\%$ ) |
|   |   | $d \leq 1.25\text{mm}$  | 20N ( $\pm 10\%$ ) |
|   |   | 彎曲 Bending $U_b$ (4*90°, duration : 2 times/bend)   |                    |
|   |   | 線徑 Wire diameter  | 負載 Load            |
| 4.4 耐焊接熱<br>Resistance to soldering heat        |   | $d \leq 0.8\text{mm}$   | 5N ( $\pm 10\%$ )  |
|   |   | $d \leq 1.25\text{mm}$  | 10N ( $\pm 10\%$ ) |
| 4.5 可焊性<br>Solderability                        |   | 無預乾燥 No pre-drying,<br>焊接溫度 Solder bath: 260 $\pm$ 5°C<br>焊接時間 Solder time: 5 $\pm$ 0.5sec  |                    |
| 4.20 標記耐溶劑<br>Solvent resistance of the marking |   | 焊接溫度 Solder temperature: 235 $\pm$ 5°C<br>焊接時間 Solder time: 2 $\pm$ 0.5sec  |                    |
| 4.6 溫度快速變化<br>Rapid change of temperature       | 無可見損壞，標記清晰<br>No visible damage, Legible marking<br>最終測量結果 Final measurements<br>$\Delta C/C \leq 5\%$ of the initial value   | 溶劑 Solvent: Isopropyl alcohol<br>溶劑溫度 Solvent temperature: 25°C<br>擦拭材料 Rubbing material: Cotton wool<br>浸漬時間 Immersion time: 5 min |                    |
| 4.7 振動<br>Vibration                             |   | 下限溫度 Lower temperature: -40°C<br>上限溫度 Upper temperature: 110°C<br>循環次數 Number of cycles: 5 times<br>持續時間 Duration $t_1 = 30$ min    |                    |
| 4.8 碰撞<br>Bump                                  |   | 頻率範圍 Frequency range: 10~55Hz<br>振幅軸向 Course: X、Y、Z (axis)<br>持續時間 2h / axis ( 6h in total)<br>位移振幅 Displacement amplitude: 0.75mm  |                    |
| 4.11 氣候序列<br>Climatic sequence                  | 無可見損壞，標記清晰<br>No visible damage, Legible marking<br>最終測量結果 Final measurements<br>(1) $\Delta C/C \leq 5\%$ of the initial value<br>(2) Increase of $\tan \delta$ over:<br>$\leq 0.008$ for $C_N \leq 1\mu\text{F}$ or $\leq 0.005$ for $C_N > 1\mu\text{F}$<br>(3) Voltage proof:<br>No permanent breakdown or flashover<br>IR $\geq 50\%$ of the applicable limits | 加速度 Acceleration: 400m/s <sup>2</sup> , 4000 times<br>脈沖持續時間 Pulse duration: 6ms  |                    |
|   |   | 乾熱 Dry Heat<br>上限溫度 Upper temperature: 110°C<br>持續時間 Duration: 16Hrs<br>濕熱循環 Damp heat, cyclic, Test Db,<br>第一次循環 First cycle       |                    |
|   |   | 寒冷 Cold<br>下限溫度 Lower temperature: -40°C<br>持續時間 Duration: 2Hrs<br>濕熱循環 Damp heat, cyclic, Test Db,<br>剩餘循環 Remaining cycle         |                    |

EMI Suppression Capacitor, Class X1

■ 檢驗要求 Inspection requirements

| 試驗項目 Test items                         | 性能要求 Performance requirements   | 試驗條件 Conditions of test   |        |           |            |        |   |    |    |    |   |    |    |    |
|---|---|---|--------|-----------|------------|--------|---|----|----|----|---|----|----|----|
| 4.12 濕熱穩態<br>Damp Heat, Steady State    | 無可見損壞, 標記清晰<br>No visible damage, Legible marking<br>最終測量結果 Final measurements<br>(1) $\Delta C/C \leq 5\%$ of the initial value<br>(2) Increase of $\tan \delta$ over:<br>$\leq 0.008$ for $C_N \leq 1\mu F$ or $\leq 0.005$ for $C_N > 1\mu F$<br>(3) Voltage proof:<br>No permanent breakdown or flashover<br>(4) $IR \geq 50\%$ of the applicable limits  | 溫度 Temperature: $40^\circ C \pm 2^\circ C$<br>濕度 Relative humidity: $93 \pm 3\%$<br>持續時間 Duration: 56 days  |        |           |            |        |   |    |    |    |   |    |    |    |
| 4.14 耐久性<br>Endurance                   | 無可見損壞, 標記清晰<br>No visible damage, Legible marking<br>最終測量結果 Final measurements<br>(1) $\Delta C/C \leq 10\%$ of the initial value<br>(2) Increase of $\tan \delta$ over:<br>$\leq 0.008$ for $C_N \leq 1\mu F$ or $\leq 0.005$ for $C_N > 1\mu F$<br>(3) Voltage proof:<br>No permanent breakdown or flashover<br>(4) $IR \geq 50\%$ of the applicable limits | 額定電壓 x 125%, 每小時上升至 1000VAC 0.1 秒<br>上限類別溫度, 1000 小時<br>$1.25 \times U_R$ VAC 50 Hz, once every hour<br>increase to 1,000VAC for 0.1 second,<br>1,000 hours at upper category temperature   |        |           |            |        |   |    |    |    |   |    |    |    |
| 4.15 充電和放電<br>Charge and discharge      | 最終測量結果 Final measurements<br>(1) $\Delta C/C \leq 10\%$ of the initial value<br>(2) Increase of $\tan \delta$ over:<br>$\leq 0.008$ for $C_N \leq 1\mu F$ or $\leq 0.005$ for $C_N > 1\mu F$<br>(3) $IR \geq 50\%$ of the applicable limits   | 實驗電壓 Test voltage : $\sqrt{2} \times U_R$ VDC<br>充放電 Charge and discharge: 1 sec/time<br>重複次數 Repeated for 10000 cycles   |        |           |            |        |   |    |    |    |   |    |    |    |
| 4.17 阻燃性試驗<br>Passive flammability test | 電容器移開火焰後 · B 類電容器持續燃燒時間不得超過 10s · C 類電容器持續燃燒時間不得超過 30s<br>After removing test flame from capacitor,<br>The capacitor must not continue to burn for more than 10s for Class B, To 30s for Class C<br>棉紙不得點燃 The tissue paper shall not ignite  | 實際體積 V 的試驗持續時間: (單位: mm <sup>3</sup> )<br>Test duration for actual volume V in mm <sup>3</sup> : <table border="1" data-bbox="970 1541 1489 1697"> <thead> <tr> <th>Class</th> <th>250&lt;V≤500</th> <th>500&lt;V≤1750</th> <th>V&gt;1750</th> </tr> </thead> <tbody> <tr> <td>B</td> <td>20</td> <td>30</td> <td>60</td> </tr> <tr> <td>C</td> <td>10</td> <td>20</td> <td>30</td> </tr> </tbody> </table> | Class  | 250<V≤500 | 500<V≤1750 | V>1750 | B | 20 | 30 | 60 | C | 10 | 20 | 30 |
| Class                                   | 250<V≤500   | 500<V≤1750  | V>1750 |           |            |        |   |    |    |    |   |    |    |    |
| B                                       | 20  | 30  | 60     |           |            |        |   |    |    |    |   |    |    |    |
| C                                       | 10  | 20  | 30     |           |            |        |   |    |    |    |   |    |    |    |
| 4.18 自燃性試驗<br>Active flammability test  | 連接至 $U_{RAC}$ 的試驗電容器上 20 次 2.5kV 放電循環<br>20 cycles of 2.5kV discharges on the test capacitor connected to $U_{RAC}$   | 電容器周圍的紗布不得燃燒<br>The cheese cloth around the capacitors shall not burn with a flame  |        |           |            |        |   |    |    |    |   |    |    |    |



EMI Suppression Capacitor, Class X1

■ 特性 Characteristics

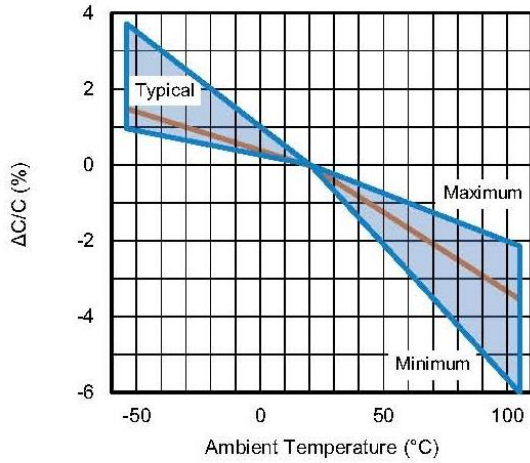

Capacitance as a function of ambient temperature (typical curve)

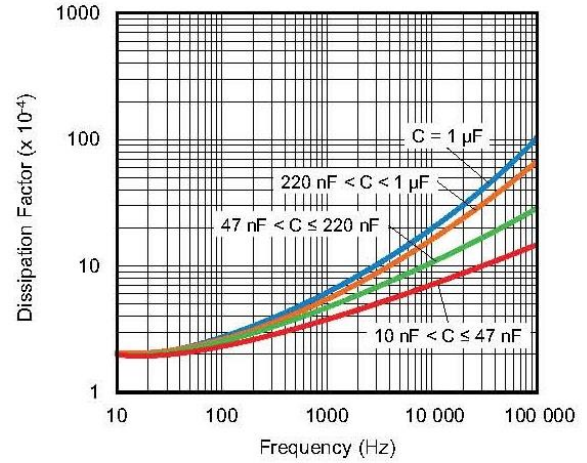

Tangent of loss angle as a function of frequency (typical curve)

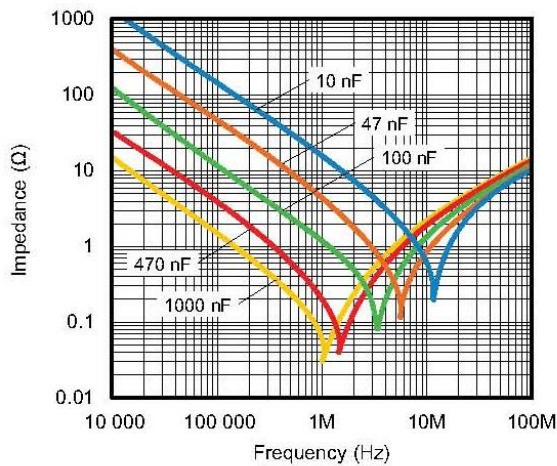

Impedance as a function of frequency (typical curve)

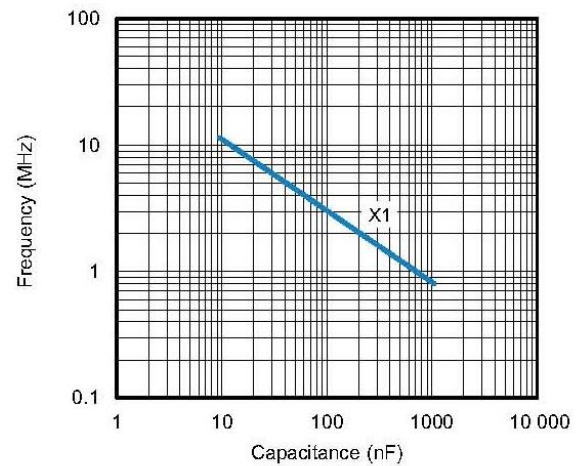

Resonant frequency as a function of capacitance (typical curve)

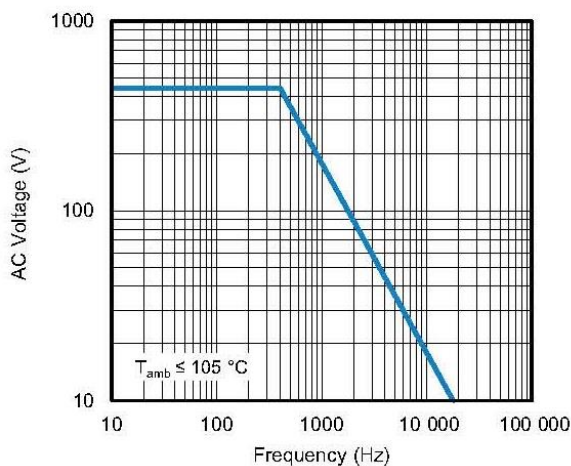

Max. RMS voltage as a function of frequency

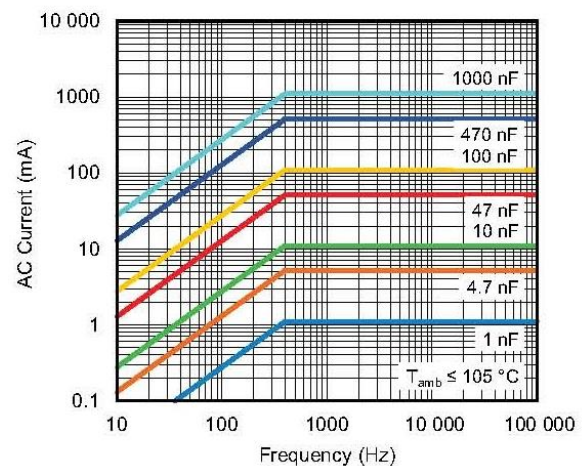

Max. RMS current as a function of frequency

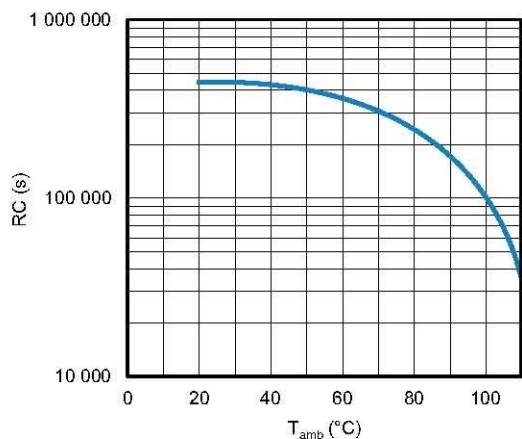

EMI Suppression Capacitor, Class X1

■ 特性 Characteristics

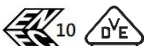

Insulation resistance as a function of ambient temperature

■ MPX-X1 型安全標準認證表 Approval sheets for safety standard of type MPX-X1

| 認證標誌<br>Approval marks  | 標準<br>Standards   | 證書號<br>Certificate | 氣候類別<br>Climatic Category | 容量範圍<br>Capacitance Range | 額定電壓<br>Rated Voltage          |
|---|-------------------|--------------------|---------------------------|---------------------------|--------------------------------|
|  | UL-60384-14       | E302125            | 40/110/56                 | 0.001 ~ 4.7μF             | 310Vac、380Vac<br>440Vac、500Vac |
|  | IEC 60384-14:2013 | 40049581           |                           |                           |                                |
|  | IEC 60384-14:2013 | CQC17001161585     |                           |                           |                                |

## EMI Suppression Capacitor, Class X1

### ■ 薄膜電容器焊接指南 Soldering Guidelines for Film Capacitors

聚丙烯膜電容器對熱特別敏感 (聚丙烯膜的熔點為 160°C ~ 170°C) , 波峰焊可能具有破壞性 , 尤其是對於小型聚丙烯膜電容器 (引線間距為 5 mm 至 15 mm) , 焊接過程中必須非常小心。

一般來說 , IEC 出版物 61760-1 第 2 版中的波峰焊接曲線可作為成功焊接的可靠指南。(請參見圖 1)

Polypropylene capacitors are especially sensitive to heat (the melting point of polypropylene is 160 – 170°C).

Wave soldering can be destructive, especially for mechanically small polypropylene capacitors (with lead spacing of 5 – 15 mm), and great care must be taken during soldering. In general, the wave soldering curve from IEC Publication 61760-1 Edition 2 serves as a solid guideline for successful soldering. See Figure 1.

通孔的薄膜電容器不建議採用回流焊。將電容器暴露在超過上述建議限值可能會導致電容器退化或永久性損壞。

Reflow soldering is not recommended for through-hole film capacitors. Exposing capacitors to a soldering profile in excess of the recommended limits may result in degradation or permanent damage to the capacitors.

請勿將聚丙烯膜電容器通過粘合劑固化爐來固化表面安裝部件的樹脂 , 須在表面安裝零件固化後插入通孔零件。

如果通孔部件必須通過粘合劑固化過程 , 請諮詢 WINDAY , 討論烘箱中的實際溫度分布。

建議最多進行兩次焊接循環。在第二次焊接循環之前 , 請留出時間使電容器表面溫度恢復到正常溫度。

Do not place the polypropylene capacitor through an adhesive curing oven to cure resin for surface mount components.

Insert through-hole parts after curing the surface mount parts. Contact WINDAY to discuss the actual temperature profile in the oven, if through-hole components must pass through the adhesive curing process.

A maximum two soldering cycles is recommended.

Allow time for the capacitor surface temperature to return to normal before the second soldering cycle.

### ■ 波峰焊建議 Wave Soldering Recommendations (Figure 1)

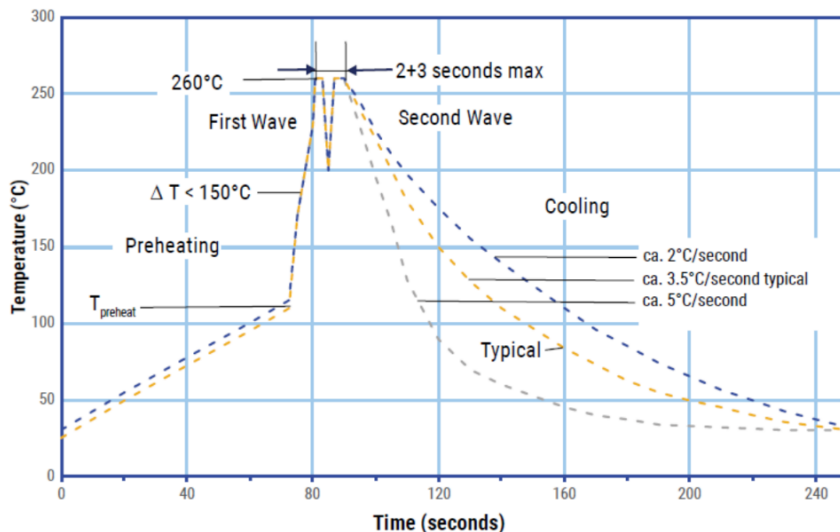

EMI Suppression Capacitor, Class X1

■ 波峰焊建議 Wave Soldering Recommendations (Continue)

1. 該表顯示了焊接過程的最高設置溫度 The tables indicates the maximum set-up temperature of the soldering process

| 介電薄膜材料<br>Dielectric Film Material | 最高預熱溫度<br>Max. Preheat Temperature |               | 最高峰值焊接溫度<br>Max. Peak Soldering Temperature |               |
|------------------------------------|------------------------------------|---------------|---|---------------|
|                                    | Pitch ≤ 15 mm                      | Pitch > 15 mm | Pitch ≤ 15 mm                               | Pitch > 15 mm |
| 聚乙酯膜 Polyester                     | 130°C                              | 130°C         | 270°C                                       | 270°C         |
| 聚丙烯膜 Polypropylene                 | 110°C                              | 130°C         | 260°C                                       | 270°C         |

2. 電容器內部測得的最高溫度 The maximum temperature measured inside the capacitor

| 介電薄膜材料<br>Dielectric Film Material | 元件內部測得的最高溫度<br>Maximum Temperature Measured Inside the Element |
|------------------------------------|--|
| 聚乙酯膜 Polyester                     | 160°C  |
| 聚丙烯膜 Polypropylene                 | 110°C  |

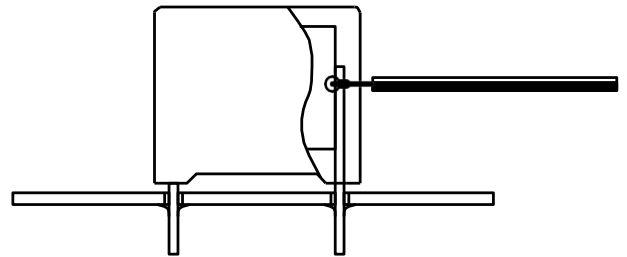

設置溫度，使元件內最高溫度低於極限：

Set the temperature so that inside the element the maximum temperature is below the limit.

■ 儲存條件和期限 Storage conditions and duration

包裝好的電容器應存放在清潔、通風、乾燥的庫房內，不靠近熱源，不受陽光直射，嚴禁與化學試劑、酸和有害氣體一起儲存。T<sub>stg</sub> = +5°C 至 +35°C，最大相對濕度為 75%，無冷凝，儲存一年。

Packaged capacitors should be kept in clean, ventilated, dry coffers, not near the heat source, not subject to direct sunlight, is strictly prohibited and chemical reagents, acid and harmful gas storage together.

T<sub>stg</sub> = +5°C to +35°C with relative humidity of maximum 75% without condensation, storage for one year.

EMI Suppression Capacitor, Class X1

■ 引線編帶 Lead Taping (IEC 60286-2) Table II

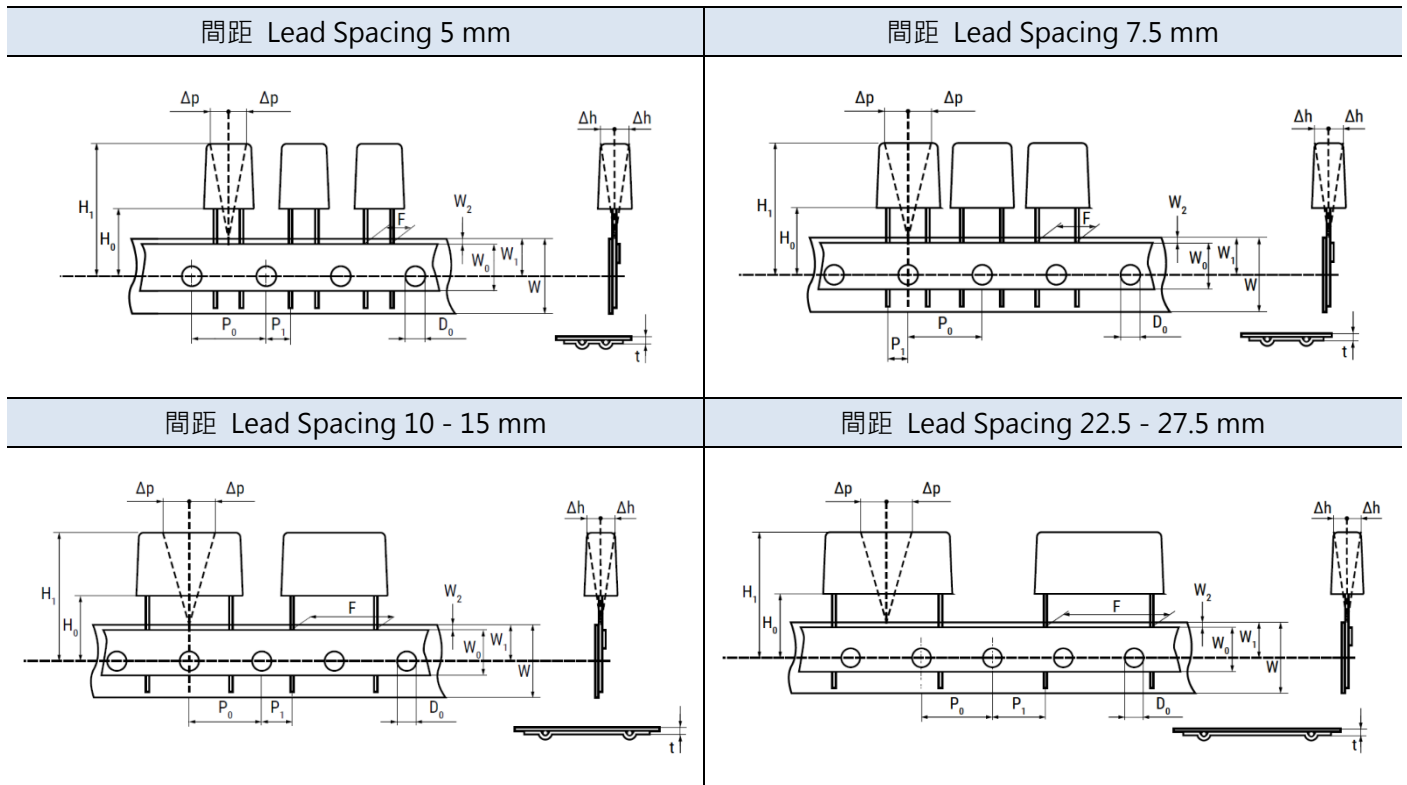

■ 編帶規格 Taping Specification

| 尺寸單位 Dimensions in mm          |                     |                               |      |      |      |      |      |      |
|--------------------------------|---------------------|-------------------------------|------|------|------|------|------|------|
| 引線間距 Lead Spacing              | +0.8/-0.2           | F                             | 5    | 7.5  | 10   | 15   | 22.5 | 27.5 |
| 載帶寬度 Carrier Tape Width        | +1/-0.5             | W                             | 18   | 18   | 18   | 18   | 18   | 18   |
| 膠帶寬度 Hold-down Tape Width      | Minimum             | W <sub>0</sub>                | 9.5  | 9.5  | 9.5  | 9.5  | 9.5  | 9.5  |
| 鏈孔位置 Position of Sprocket Hole | ±0.5                | W <sub>1</sub>                | 9    | 9    | 9    | 9    | 9    | 9    |
| 帶與帶距 Distance Between Tapes    | Minimum             | W <sub>2</sub>                | 3    | 3    | 3    | 3    | 3    | 3    |
| 鏈孔直徑 Sprocket Hole Diameter    | ±0.2                | D <sub>0</sub>                | 4    | 4    | 4    | 4    | 4    | 4    |
| 進料孔距 Feed Hole Lead Spacing    | ±0.2 <sup>(1)</sup> | P <sub>0</sub> <sup>(3)</sup> | 12.7 | 12.7 | 12.7 | 12.7 | 12.7 | 12.7 |
| 引線-鏈孔 Distance Lead-Feed Hole  | ±0.7                | P <sub>1</sub>                | 3.85 | 3.75 | 7.7  | 5.2  | 7.8  | 5.3  |
| 平面偏差 Deviation Tape - Plane    | Minimum             | Δp                            | 1.3  | 1.3  | 1.3  | 1.3  | 1.3  | 1.3  |
| 橫向偏差 Lateral Deviation         | ±2                  | Δh                            | 2    | 2    | 2    | 2    | 2    | 2    |
| 總厚度 Total Thickness            | ±0.2                | T                             | 0.7  | 0.7  | 0.7  | 0.7  | 0.7  | 0.7  |
| 鏈孔-本體 Sprocket Hole/Cap Body   | ±0.5                | H <sub>0</sub> <sup>(2)</sup> | 18.5 | 18.5 | 18.5 | 18.5 | 18.5 | 18.5 |

(1) 最大累計進料孔誤差：每20個零件 1mm / Maximum cumulative feed hole error, 1 mm per 20 parts.

(2) 16.5 mm 可根據要求提供 / 16.5 mm available on request.

(3) 15.0 mm 可根據要求提供 / 15.0 mm available on request (F ≥ 10mm).