

EMI Suppression Capacitor, Class X2

■ 外形圖 Outline Drawing (For Example)

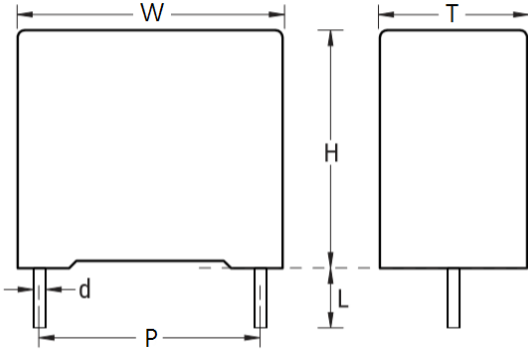

■ 典型應用

適用於需要 X2 安全等級的跨線應用中的電磁干擾 (EMI) 抑制。用於電容器故障不會導致觸電的情況。不用於“串聯電源”型應用。

■ 特徵

金屬化聚丙烯薄膜徑向鍍錫引線。
電容器封裝在自熄耐溶劑塑料殼中。
採用符合 UL 94 V-0 要求的熱固性樹脂材料。

■ 規格 Specifications

參考標準 Reference Standard	GB/T 6346.14 (IEC 60384-14)	
容量範圍 Capacitance Range	0.001 μ F ~ 2.2 μ F	
容量誤差 Capacitance Tolerance	\pm 10% (K)	
額定電壓 Rated Voltage (U_R)	275Vac (310Vac)	
氣候類別 Climatic Category	40/110/21	
工作溫度範圍 Operating Temperature Range	-40°C~110°C	
被動可燃性等級 Passive Flammability Class	C	
耐電壓 Voltage Proof	引線間 Between Terminals	$U_R \times 4.3$ (DC), 60s
	引線與外殼間 Between Terminal and Case	$U_R \times 200\% + 1500$ Vac, 60sec.
損耗因素 Dissipation Factor	$\leq 10 \times 10^{-4}$ at 1kHz, (1Vrms Max. at 20°C)	
絕緣電阻 Insulation Resistance	$C_R \leq 0.33\mu$ F, IR ≥ 15000 M Ω	
	$C_R > 0.33\mu$ F, IR $\times C_R \geq 5000$ s (100Vdc, 60sec / 20°C)	

■ 構造 Construction

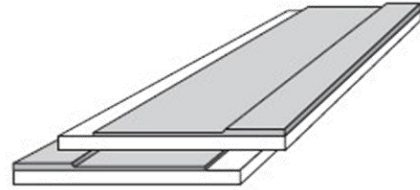

■ Typical Applications

For worldwide use in electromagnetic interference (EMI) suppression in across-the-line applications requiring X2 safety classification. Intended for use in situations where capacitor failure would not result in exposure to electric shock. Not for use in "series with mains" type applications.

■ Features

Metallized polypropylene film with radial leads of tinned wire. The capacitor is encapsulated in a self-extinguishing solvent resistant plastic case with thermosetting resin material meeting UL 94 V-0 requirements.

EMI Suppression Capacitor, Class X2

■ 產品代碼構成 Product code system (For Example)

SMXD	G	104	K	D2X5	A	B	15	15
型號 Type	內部使用 Internal Use	容值 Capacitance	公差 Tolerance	外殼代碼 Case Code	交直流 AC/DC	引線成形 Lead Forming	引線間距 Lead Pitch	引線長度 Lead Length
SMXD=	--	104	K=±10%	D2X5=18*12*6	A=AC	(表一)	08=7.5mm	04=3.5mm
EMI		=100nF		D3XX=18*13.5*7.5		Shown as	10=10mm	15=15mm
Suppression		=0.1μF		D4XX=18*14.5*8.5		Table I	15=15mm	23=23mm
Capacitor				E4XX=26.5*19*10			23=22.5mm	
				F3XX=31*25*14			28=27.5mm	

(表一) Table I

引線成形 Lead Forming			
B (Straight 15mm)	K (Short)	U (Vertical Kink)	T (Taping)

■ 標示 Marking (For Example)

Marking	
$\geq 0.001\mu\text{F } C_R \leq 1.0\mu\text{F}$	$> 1.0\mu\text{F } C_R \leq 2.2\mu\text{F}$
1. Capacitance: 1.0μF and 1.5μF	2. Capacitors Tolerance: K=±10%
3. Rated Voltage: 275V~ and 310V~	4. Capacitors Class: X2
5. Type of the Capacitors: MPX	6. DAIN is a trademark
7. Climatic Category: 40/110/21	8. Passive flammability category: C
9. Recognized Approval Mark	10. Date Code: 03M/19Y

EMI Suppression Capacitor, Class X2

■ Dimensions (mm)

275Vac / 310Vac						
Cap. μF	W	H	T	P	d	Part number
0.0010	10	9	4	7.5	0.6	SMXDI102KB3LTA*08**
0.0022	10	9	4	7.5	0.6	SMXDI222KB3LTA*08**
0.0033	10	9	4	7.5	0.6	SMXDF332KB3LTA*08**
0.0047	10	9	4	7.5	0.6	SMXDJ472KB3LTA*08**
0.0068	10	9	4	7.5	0.6	SMXDI682KB3LTA*08**
0.010	10	9	4	7.5	0.6	SMXDI103KB3LTA*08**
0.022	10	10	5	7.5	0.6	SMXDH223KB7LTA*08**
0.033	10	12	6	7.5	0.6	SMXDI333KB5LTA*08**
0.047	10	12	6	7.5	0.6	SMXDG473KB5LTA*08**
0.068	10	12	6	7.5	0.6	SMXDG683KB5LTA*08**
0.1	10	12	6	7.5	0.6	SMXDF104KB5LTA*08**
0.0010	13	9	4	10	0.6	SMXDJ102KC1XXA*10**
0.0010	13	11	5	10	0.6	SMXDJ102KC2X1A*10**
0.0022	13	9	4	10	0.6	SMXDI222KC1XXA*10**
0.0022	13	11	5	10	0.6	SMXDJ222KC2X1A*10**
0.0033	13	9	4	10	0.6	SMXDJ332KC1XXA*10**
0.0033	13	11	5	10	0.6	SMXDJ332KC2X1A*10**
0.0047	13	9	4	10	0.6	SMXDJ472KC1XXA*10**
0.0047	13	11	5	10	0.6	SMXDJ472KC2X1A*10**
0.0068	13	9	4	10	0.6	SMXDJ682KC1XXA*10**
0.0068	13	11	5	10	0.6	SMXDI682KC2X1A*10**
0.010	13	9	4	10	0.6	SMXDI103KC1XXA*10**
0.010	13	11	5	10	0.6	SMXDJ103KC2X1A*10**
0.022	13	9	4	10	0.6	SMXDH223KC1XXA*10**
0.022	13	11	5	10	0.6	SMXDI223KC2X1A*10**
0.033	13	9	4	10	0.6	SMXDG333KC1XXA*10**
0.033	13	11	5	10	0.6	SMXDH333KC2X1A*10**
0.047	13	9	4	10	0.6	SMXDF473KC1XXA*10**
0.047	13	11	5	10	0.6	SMXDG473KC2X1A*10**
0.068	13	11	5	10	0.6	SMXDG683KC2X1A*10**
0.068	13	12	6	10	0.6	SMXDG683KC3XXA*10**

275Vac / 310Vac						
Cap. μF	W	H	T	P	d	Part number
0.10	13	11	5	10	0.6	SMXDF104KC2X1A*10**
0.10	13	12	6	10	0.6	SMXDG104KC3XXA*10**
0.15	13	12	6	10	0.6	SMXDF154KC3XXA*10**
0.15	13	14	8	10	0.6	SMXDG154KC5LTA*10**
0.22	13	12	6	10	0.6	SMXDE224KC3XXA*10**
0.22	13	14	8	10	0.6	SMXDF224KC5LTA*10**
0.33	13	14	8	10	0.6	SMXDE334KC5LTA*10**
0.33	12.5	16.5	10.5	10	0.6	SMXDF334KC9XXA*10**
0.47	13	14	8	10	0.6	SMXDE474KC5LTA*10**
0.47	12.5	16.5	10.5	10	0.6	SMXDF474KC9XXA*10**
0.010	18	11	5	15	0.8	SMXDJ103KD1XXA*15**
0.022	18	11	5	15	0.8	SMXDJ223KD1XXA*15**
0.033	18	11	5	15	0.8	SMXDI333KD1XXA*15**
0.047	18	11	5	15	0.8	SMXDI473KD1XXA*15**
0.068	18	11	5	15	0.8	SMXDH683KD1XXA*15**
0.10	18	11	5	15	0.8	SMXDG104KD1XXA*15**
0.10	18	12	6	15	0.8	SMXDG104KD2X5A*15**
0.15	18	11	5	15	0.8	SMXDF154KD1XXA*15**
0.15	18	12	6	15	0.8	SMXDG154KD2XXA*15**
0.22	18	12	6	15	0.8	SMXDF224KD2XXA*15**
0.22	18	13.5	7.5	15	0.8	SMXDG224KD3X5A*15**
0.22	18	14.5	8.5	15	0.8	SMXDG224KD4X5A*15**
0.33	18	12	6	15	0.8	SMXDE334KD2XXA*15**
0.33	18	13.5	7.5	15	0.8	SMXDF334KD3XXA*15**
0.33	18	14.5	8.5	15	0.8	SMXDG334KD4XXA*15**
0.33	18	15.5	9.5	15	0.8	SMXDG334KD5XXA*15**
0.47	18	14.5	8.5	15	0.8	SMXDF474KD4XXA*15**
0.47	18	15.5	9.5	15	0.8	SMXDG474KD5XXA*15**
0.47	18	19	10.8	15	0.8	SMXDG474KD7XXA*15**
0.68	18	15.5	9.5	15	0.8	SMXDF684KD5XXA*15**
0.68	18	19	10.8	15	0.8	SMXDG684KD7XXA*15**

EMI Suppression Capacitor, Class X2

■ Dimensions (mm)

275Vac / 310Vac						
Cap. μF	W	H	T	P	d	Part number
0.82	18	19	10.8	15	0.8	SMXDF824KD7XXA*15**
1.0	18	19.2	11.2	15	0.8	SMXDF105KD8X3A*15**
0.22	26.5	15	6	22.5	0.8	SMXDH224KE1XXA*23**
0.22	26.5	16.5	7	22.5	0.8	SMXDH224KE2XXA*23**
0.33	26.5	16.5	7	22.5	0.8	SMXDH334KE2XXA*23**
0.33	26.5	17	8.5	22.5	0.8	SMXDH334KE3X5A*23**
0.47	26.5	15	6	22.5	0.8	SMXDF474KE1XXA*23**
0.47	26.5	16.5	7	22.5	0.8	SMXDG474KE2XXA*23**
0.47	26.5	17	8.5	22.5	0.8	SMXDG474KE3X5A*23**
0.47	26.5	19	10	22.5	0.8	SMXDH474KE4X5A*23**
0.68	26.5	16.5	7	22.5	0.8	SMXDF684KE2XXA*23**
0.68	26.5	17	8.5	22.5	0.8	SMXDG684KE3XXA*23**
0.68	26.5	19	10	22.5	0.8	SMXDH684KE4XXA*23**
0.82	26.5	19	10	22.5	0.8	SMXDG824KE4XXA*23**
0.82	26	21.5	12	22.5	0.8	SMXDH824KE6XXA*23**
1.0	26.5	17	8.5	22.5	0.8	SMXDF105KE3XXA*23**
1.0	26.5	19	10	22.5	0.8	SMXDG105KE4XXA*23**
1.0	26	21.5	12	22.5	0.8	SMXDH105KE6XXA*23**
1.2	26.5	19	10	22.5	0.8	SMXDF125KE4XXA*23**
1.2	26	21.5	12	22.5	0.8	SMXDG125KE6XXA*23**
1.5	26.5	19	10	22.5	0.8	SMXDF155KE4XXA*23**
1.5	26	20	11	22.5	0.8	SMXDF155KE5XXA*23**
1.5	26	21.5	12	22.5	0.8	SMXDF155KE6XXA*23**
1.5	26.5	23	13	22.5	0.8	SMXDG155KE7XXA*23**
1.8	26	21.5	12	22.5	0.8	SMXDF185KE6XXA*23**
1.8	26	25	15	22.5	0.8	SMXDG185KE24LA*23**
2.2	26.5	23	13	22.5	0.8	SMXDF225KE7XXA*23**
2.2	26	25	15	22.5	0.8	SMXDG225KE24LA*23**
0.47	31	16	10	27.5	0.8	SMXDI474KF15XA*28**
0.47	31.5	19.5	10.8	27.5	0.8	SMXDI474KF1X5A*28**
0.68	31.5	19.5	10.8	27.5	0.8	SMXDH684KF1X5A*28**

275Vac / 310Vac						
Cap. μF	W	H	T	P	d	Part number
0.82	31.5	19.5	10.8	27.5	0.8	SMXDH824KF1X5A*28**
0.82	31.5	21.5	13	27.5	0.8	SMXDH824KF2X5A*28**
1.0	31.5	19.5	10.8	27.5	0.8	SMXDG105KF1X5A*28**
1.0	31.5	21.6	13	27.5	0.8	SMXDH105KF2XXA*28**
1.0	31	25	14	27.5	0.8	SMXDI105KF3XXA*28**
1.2	31.5	19.5	10.8	27.5	0.8	SMXDG125KF1X5A*28**
1.2	31.5	21.6	13	27.5	0.8	SMXDH125KF2XXA*28**
1.5	31.5	19.5	10.8	27.5	0.8	SMXDG155KF1XXA*28**
1.5	31.5	21.6	13	27.5	0.8	SMXDG155KF2XXA*28**
1.5	31	25	14	27.5	0.8	SMXDH155KF3XXA*28**
1.8	31	25	14	27.5	0.8	SMXDG185KF3XXA*28**
2.0	31.5	19.5	10.8	27.5	0.8	SMXDF205KF1XXA*28**
2.0	31.5	21.6	13	27.5	0.8	SMXDF205KF2XXA*28**
2.0	31	25	14	27.5	0.8	SMXDG205KF3XXA*28**
2.2	31.5	21.6	13	27.5	0.8	SMXDF225KF2XXA*28**
2.2	31	25	14	27.5	0.8	SMXDG225KF3XXA*28**
2.2	31	29	15.5	27.5	0.8	SMXDH225KF31LA*28**
2.2	32	28	18	27.5	0.8	SMXDH225KF13XA*28**

(1) The symbol * means style of lead forming

(2) The symbol ** means the lead length

■ 檢驗要求 Inspection requirements

試驗項目 Test items	性能要求 Performance requirements	試驗條件 Conditions of test	
4.3 引出端強度 Robustness of terminations	無斷線，電容器無可見損壞 No wire breakage and no damage of capacitor 最終測量結果 Final measurements (1) 無可見損壞 No visible damage (2) $\Delta C/C \leq 5\%$ of the initial value	拉力 Tensile U_{a1} (Duration : 10s \pm 1s)	
		線徑 Wire diameter	負載 Load
		$d \leq 0.8\text{mm}$	10N ($\pm 10\%$)
		$d \leq 1.25\text{mm}$	20N ($\pm 10\%$)
		彎曲 Bending U_b (4*90°, duration : 2 times/bend)	
		線徑 Wire diameter	負載 Load
4.4 耐焊接熱 Resistance to soldering heat		$d \leq 0.8\text{mm}$	5N ($\pm 10\%$)
		$d \leq 1.25\text{mm}$	10N ($\pm 10\%$)
4.5 可焊性 Solderability		無預乾燥 No pre-drying, 焊接溫度 Solder bath: 260 \pm 5°C 焊接時間 Solder time: 5 \pm 0.5sec	
4.20 標記耐溶劑 Solvent resistance of the marking		焊接溫度 Solder temperature: 235 \pm 5°C 焊接時間 Solder time: 2 \pm 0.5sec	
4.6 溫度快速變化 Rapid change of temperature	無可見損壞，標記清晰 No visible damage, Legible marking 最終測量結果 Final measurements $\Delta C/C \leq 5\%$ of the initial value	溶劑 Solvent: Isopropyl alcohol 溶劑溫度 Solvent temperature: 25°C 擦拭材料 Rubbing material: Cotton wool 浸漬時間 Immersion time: 5 min	
4.7 振動 Vibration		下限溫度 Lower temperature: -40°C 上限溫度 Upper temperature: 110°C 循環次數 Number of cycles: 5 times 持續時間 Duration $t_1 = 30$ min	
4.8 碰撞 Bump		頻率範圍 Frequency range: 10~55Hz 振幅軸向 Course: X、Y、Z (axis) 持續時間 2h / axis (6h in total) 位移振幅 Displacement amplitude: 0.75mm	
4.11 氣候序列 Climatic sequence	無可見損壞，標記清晰 No visible damage, Legible marking 最終測量結果 Final measurements (1) $\Delta C/C \leq 5\%$ of the initial value (2) Increase of $\tan \delta$ over: ≤ 0.008 for $C_N \leq 1\mu\text{F}$ or ≤ 0.005 for $C_N > 1\mu\text{F}$ (3) Voltage proof: No permanent breakdown or flashover IR $\geq 50\%$ of the applicable limits	加速度 Acceleration: 400m/s ² , 4000 times 脈沖持續時間 Pulse duration: 6ms	
		乾熱 Dry Heat 上限溫度 Upper temperature: 110°C 持續時間 Duration: 16Hrs 濕熱循環 Damp heat, cyclic, Test Db, 第一次循環 First cycle	
		寒冷 Cold 下限溫度 Lower temperature: -40°C 持續時間 Duration: 2Hrs 濕熱循環 Damp heat, cyclic, Test Db, 剩餘循環 Remaining cycle	

■ 檢驗要求 Inspection requirements

試驗項目 Test items	性能要求 Performance requirements	試驗條件 Conditions of test												
4.12 濕熱穩態 Damp Heat, Steady State	無可見損壞, 標記清晰 No visible damage, Legible marking 最終測量結果 Final measurements (1) $\Delta C/C \leq 5\%$ of the initial value (2) Increase of $\tan \delta$ over: ≤ 0.008 for $C_N \leq 1\mu F$ or ≤ 0.005 for $C_N > 1\mu F$ (3) Voltage proof: No permanent breakdown or flashover (4) $IR \geq 50\%$ of the applicable limits	溫度 Temperature: $40^\circ C \pm 2^\circ C$ 濕度 Relative humidity: $93 \pm 3\%$ 持續時間 Duration: 21 days												
4.14 耐久性 Endurance	無可見損壞, 標記清晰 No visible damage, Legible marking 最終測量結果 Final measurements (1) $\Delta C/C \leq 10\%$ of the initial value (2) Increase of $\tan \delta$ over: ≤ 0.008 for $C_N \leq 1\mu F$ or ≤ 0.005 for $C_N > 1\mu F$ (3) Voltage proof: No permanent breakdown or flashover (4) $IR \geq 50\%$ of the applicable limits	額定電壓 x 125%, 每小時上升至 1000VAC 0.1 秒 上限類別溫度, 1000 小時 $1.25 \times U_R$ VAC 50 Hz, once every hour increase to 1,000VAC for 0.1 second, 1,000 hours at upper category temperature												
4.15 充電和放電 Charge and discharge	最終測量結果 Final measurements (1) $\Delta C/C \leq 10\%$ of the initial value (2) Increase of $\tan \delta$ over: ≤ 0.008 for $C_N \leq 1\mu F$ or ≤ 0.005 for $C_N > 1\mu F$ (3) $IR \geq 50\%$ of the applicable limits	實驗電壓 Test voltage : $\sqrt{2} \times U_R$ VDC 充放電 Charge and discharge: 1 sec/time 重複次數 Repeated for 10000 cycles												
4.17 阻燃性試驗 Passive flammability test	電容器移開火焰後 · B 類電容器持續燃燒時間不得超過 10s · C 類電容器持續燃燒時間不得超過 30s After removing test flame from capacitor, The capacitor must not continue to burn for more than 10s for Class B, To 30s for Class C 棉紙不得點燃 The tissue paper shall not ignite	實際體積 V 的試驗持續時間: (單位: mm ³) Test duration for actual volume V in mm ³ : <table border="1" data-bbox="970 1541 1497 1697"> <thead> <tr> <th>Class</th> <th>250<V≤500</th> <th>500<V≤1750</th> <th>V>1750</th> </tr> </thead> <tbody> <tr> <td>B</td> <td>20</td> <td>30</td> <td>60</td> </tr> <tr> <td>C</td> <td>10</td> <td>20</td> <td>30</td> </tr> </tbody> </table>	Class	250<V≤500	500<V≤1750	V>1750	B	20	30	60	C	10	20	30
Class	250<V≤500	500<V≤1750	V>1750											
B	20	30	60											
C	10	20	30											
4.18 自燃性試驗 Active flammability test	連接至 U_{RAC} 的試驗電容器上 20 次 2.5kV 放電循環 20 cycles of 2.5kV discharges on the test capacitor connected to U_{RAC}	電容器周圍的紗布不得燃燒 The cheese cloth around the capacitors shall not burn with a flame												

EMI Suppression Capacitor, Class X2

■ 特性 Characteristics

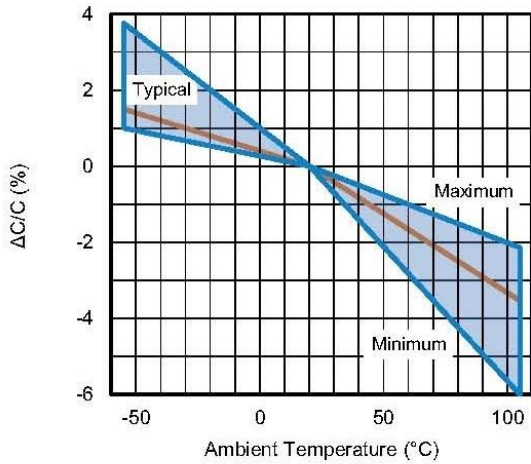

Capacitance as a function of ambient temperature (typical curve)

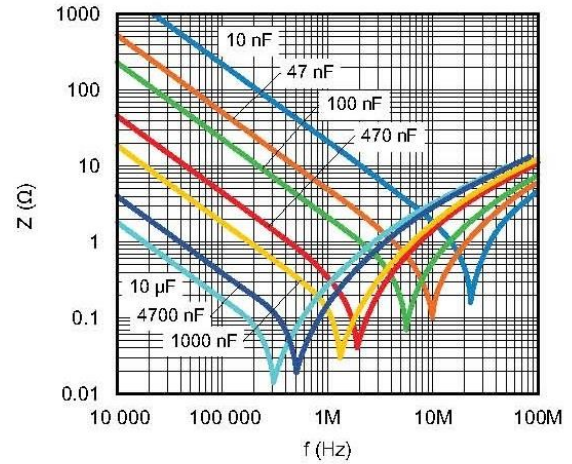

Impedance as a function of frequency (typical curve)

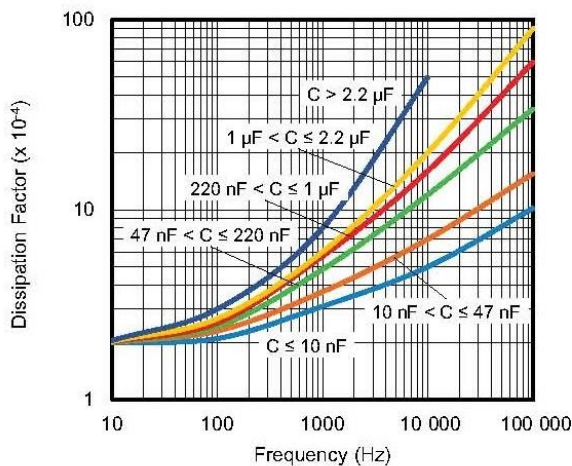

Tangent of loss angle as a function of frequency (typical curve)

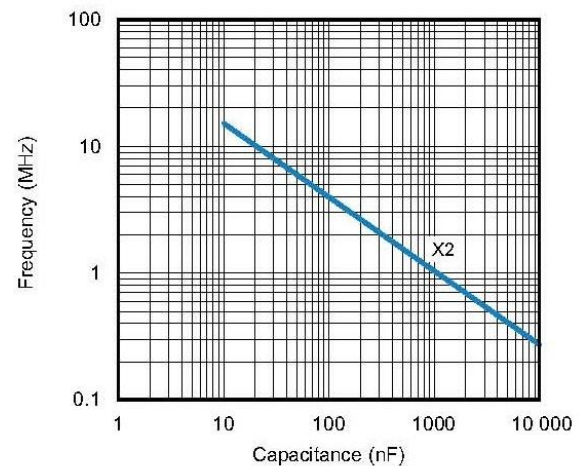

Resonant frequency as a function of capacitance (typical curve)

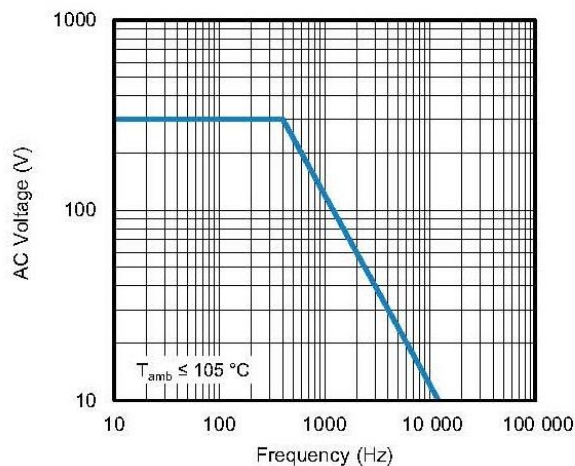

Max. RMS voltage as a function of frequency

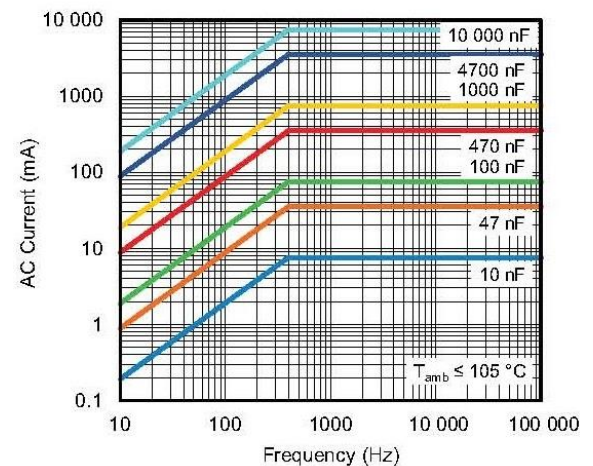

Max. RMS current as a function of frequency

EMI Suppression Capacitor, Class X2

■ 特性 Characteristics

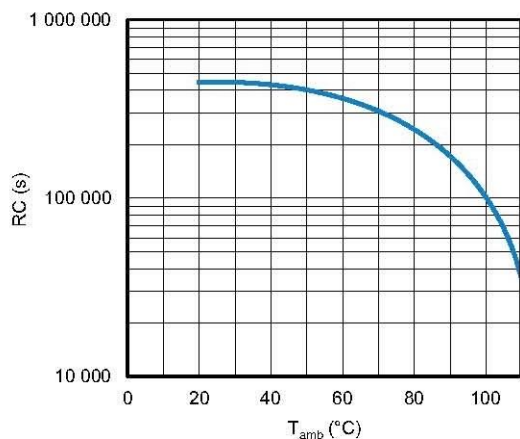

Insulation resistance as a function of ambient temperature

■ MPX-X2 型安全標準認證表 Approval sheets for safety standard of type MPX-X2

認證標志 Approval marks	標準 Standards	證書號 Certificate	氣候類別 Climatic Category	容量範圍 Capacitance Range	額定電壓 Rated Voltage
	UL 60384-14	E147776	40/110/21/C	0.001 ~ 2.2μF	275Vac (310Vac)
	EN60384-14:09	E147776	40/110/21/C	0.001 ~ 2.2μF	275Vac (310Vac)
	IEC 60384-14:2013	40018798	40/110/21/C	0.001 ~ 1.0μF	275Vac
	GB/T6346.14-2015	CQC17001166233	40/110/21/C	0.001 ~ 2.2μF	275Vac (310Vac)
	KC60384-14 (2015-09) KC60384-1 (2015-09)	SU03034-12001C SU03034-12002C SU03034-12003D SU03034-12004D SU03034-17001A	40/110/21/C	0.001 ~ 4.7μF	275Vac (310Vac)

EMI Suppression Capacitor, Class X2

■ 薄膜電容器焊接指南 Soldering Guidelines for Film Capacitors

聚丙烯膜電容器對熱特別敏感 (聚丙烯膜的熔點為 160°C ~ 170°C) , 波峰焊可能具有破壞性 , 尤其是對於小型聚丙烯膜電容器 (引線間距為 5 mm 至 15 mm) , 焊接過程中必須非常小心。

一般來說 , IEC 出版物 61760-1 第 2 版中的波峰焊接曲線可作為成功焊接的可靠指南。(請參見圖 1)

Polypropylene capacitors are especially sensitive to heat (the melting point of polypropylene is 160 – 170°C).

Wave soldering can be destructive, especially for mechanically small polypropylene capacitors (with lead spacing of 5 – 15 mm), and great care must be taken during soldering. In general, the wave soldering curve from IEC Publication 61760-1 Edition 2 serves as a solid guideline for successful soldering. See Figure 1.

通孔的薄膜電容器不建議採用回流焊。將電容器暴露在超過上述建議限值可能會導致電容器退化或永久性損壞。

Reflow soldering is not recommended for through-hole film capacitors. Exposing capacitors to a soldering profile in excess of the recommended limits may result in degradation or permanent damage to the capacitors.

請勿將聚丙烯膜電容器通過粘合劑固化爐來固化表面安裝部件的樹脂 , 須在表面安裝零件固化後插入通孔零件。

如果通孔部件必須通過粘合劑固化過程 , 請諮詢 WINDAY , 討論烘箱中的實際溫度分布。

建議最多進行兩次焊接循環。在第二次焊接循環之前 , 請留出時間使電容器表面溫度恢復到正常溫度。

Do not place the polypropylene capacitor through an adhesive curing oven to cure resin for surface mount components.

Insert through-hole parts after curing the surface mount parts. Contact WINDAY to discuss the actual temperature profile in the oven, if through-hole components must pass through the adhesive curing process.

A maximum two soldering cycles is recommended.

Allow time for the capacitor surface temperature to return to normal before the second soldering cycle.

■ 波峰焊建議 Wave Soldering Recommendations (Figure 1)

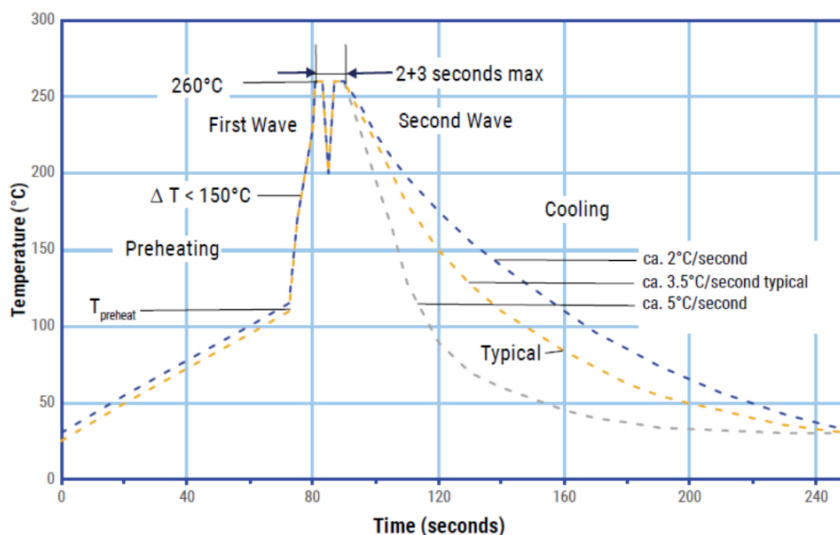

■ 波峰焊建議 Wave Soldering Recommendations (Continue)

1. 該表顯示了焊接過程的最高設置溫度 The tables indicates the maximum set-up temperature of the soldering process

介電薄膜材料 Dielectric Film Material	最高預熱溫度 Max. Preheat Temperature		最高峰值焊接溫度 Max. Peak Soldering Temperature	
	Pitch ≤ 15 mm	Pitch > 15 mm	Pitch ≤ 15 mm	Pitch > 15 mm
聚乙酯膜 Polyester	130°C	130°C	270°C	270°C
聚丙烯膜 Polypropylene	110°C	130°C	260°C	270°C

2. 電容器內部測得的最高溫度 The maximum temperature measured inside the capacitor

介電薄膜材料 Dielectric Film Material	元件內部測得的最高溫度 Maximum Temperature Measured Inside the Element
聚乙酯膜 Polyester	160°C
聚丙烯膜 Polypropylene	110°C

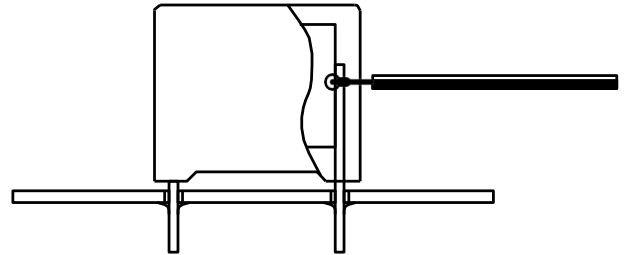

設置溫度，使元件內的最高溫度低於極限：

Set the temperature so that inside the element the maximum temperature is below the limit.

■ 儲存條件和期限 Storage conditions and duration

包裝好的電容器應存放在清潔、通風、乾燥的庫房內，不靠近熱源，不受陽光直射，嚴禁與化學試劑、酸和有害氣體一起儲存。T_{stg} = +5°C 至 +35°C，最大相對濕度為 75%，無冷凝，儲存一年。

Packaged capacitors should be kept in clean, ventilated, dry coffers, not near the heat source, not subject to direct sunlight, is strictly prohibited and chemical reagents, acid and harmful gas storage together.

T_{stg} = +5°C to +35°C with relative humidity of maximum 75% without condensation, storage for one year.

■ 引線編帶 Lead Taping (IEC 60286-2) Table II

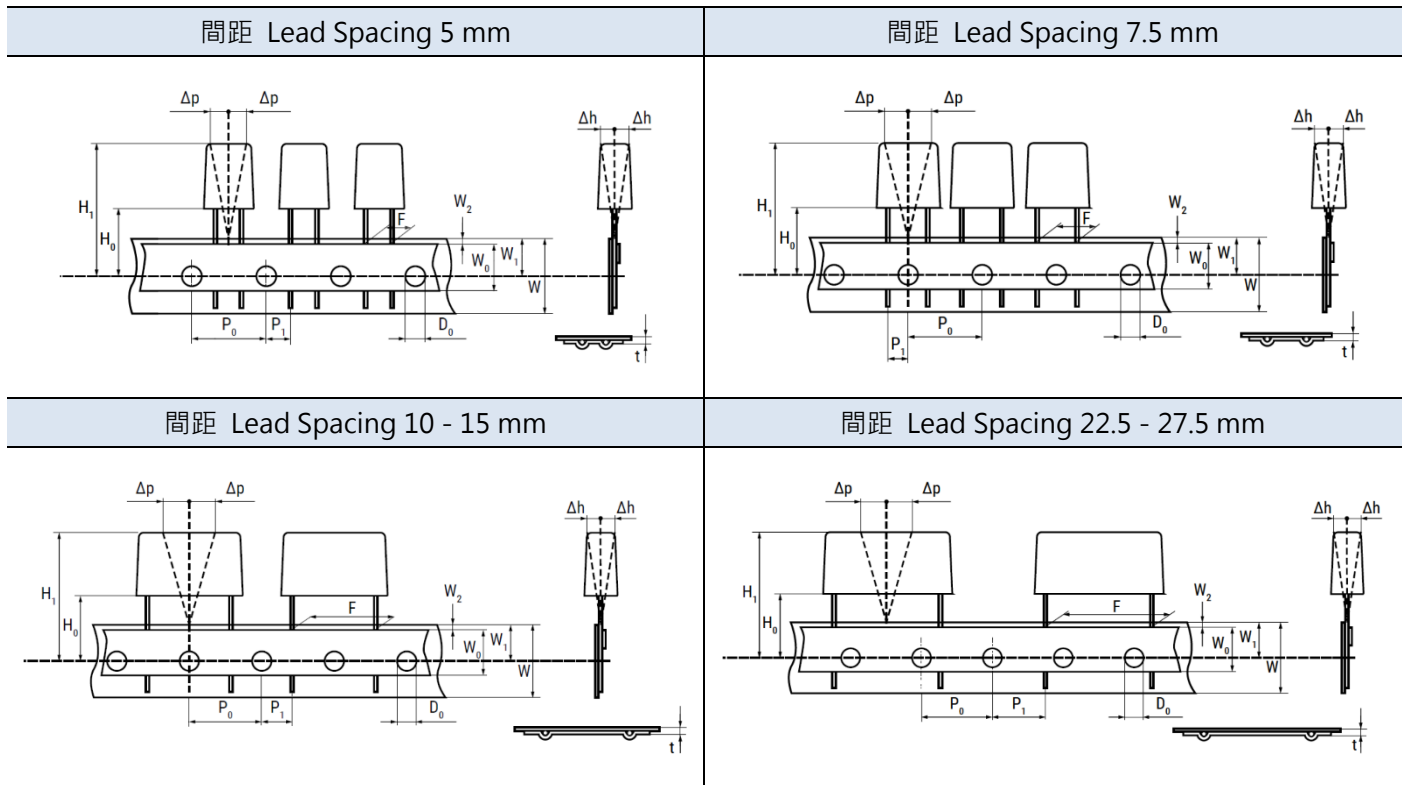

■ 編帶規格 Taping Specification

尺寸單位 Dimensions in mm								
引線間距 Lead Spacing	+0.8/-0.2	F	5	7.5	10	15	22.5	27.5
載帶寬度 Carrier Tape Width	+1/-0.5	W	18	18	18	18	18	18
膠帶寬度 Hold-down Tape Width	Minimum	W ₀	9.5	9.5	9.5	9.5	9.5	9.5
鏈孔位置 Position of Sprocket Hole	±0.5	W ₁	9	9	9	9	9	9
帶與帶距 Distance Between Tapes	Minimum	W ₂	3	3	3	3	3	3
鏈孔直徑 Sprocket Hole Diameter	±0.2	D ₀	4	4	4	4	4	4
進料孔距 Feed Hole Lead Spacing	±0.2 ⁽¹⁾	P ₀ ⁽³⁾	12.7	12.7	12.7	12.7	12.7	12.7
引線-鏈孔 Distance Lead-Feed Hole	±0.7	P ₁	3.85	3.75	7.7	5.2	7.8	5.3
平面偏差 Deviation Tape - Plane	Minimum	Δp	1.3	1.3	1.3	1.3	1.3	1.3
橫向偏差 Lateral Deviation	±2	Δh	2	2	2	2	2	2
總厚度 Total Thickness	±0.2	T	0.7	0.7	0.7	0.7	0.7	0.7
鏈孔-本體 Sprocket Hole/Cap Body	±0.5	H ₀ ⁽²⁾	18.5	18.5	18.5	18.5	18.5	18.5

(1) 最大累計進料孔誤差：每20個零件 1mm / Maximum cumulative feed hole error, 1 mm per 20 parts.

(2) 16.5 mm 可根據要求提供 / 16.5 mm available on request.

(3) 15.0 mm 可根據要求提供 / 15.0 mm available on request (F ≥ 10mm).